

BEAUTURAL

Handheld Garment Steamer



Instruction Manual

1byone Products Inc.
1230 E Belmont Street, Ontario, CA, USA 91761
Customer Service: +1 909-391-3888
www.1byonebros.com
Made in China

Introduction

Thank you for purchasing the Beautural Handheld Garment Steamer. This instruction manual contains important information about its safety, usage and disposal. Use the product as described and keep this manual for future reference. If you sell this steamer or pass it on, please also give this manual to the new owner.

Safety Instructions

- This steamer is only authorized for domestic use and not for commercial or industrial purposes. It is only intended for applications described in these instructions.
- This steamer is not intended for use by people with limited physical, sensory or mental abilities, or persons without required knowledge or experience. Product use by such people is allowed only under the supervision of the person or guardian responsible for their safety, with the guardian providing clear instructions on the device operation. Ensure that children do not play with the steamer.
- This steamer may be used by children over 8 years old and by dependents if they are properly supervised and have been made fully aware of the risks of use. Children should not play with the steamer. Cleaning and user maintenance should not be performed by children without supervision.
- If the supplied power cord is damaged, it should be replaced by a qualified technician to avoid hazard.
- Care should be taken when using the product due to the emission of steam.
- Always unplug the steamer before attaching or detaching brush attachments during filling, cleaning and de-scaling.
- Carefully read all instructions before operating the steamer for the first time and save for future reference.
- Any maintenance other than cleaning should be performed at an qualified personnel.
- Remove and safely discard any packaging material and promotional labels before using the steamer for the first time.

- Do not place the steamer near the edge of a bench or table during operation. Ensure the surface is level, clean and free of water and other substances.
- Always ensure the steamer is properly assembled before use. Only use the attachments or accessories provided and specified in this instruction manual. Follow the instructions provided in this book.
- Do not leave the steamer unattended when connected or in use.
- Do not store the steamer with water in the water tank. Always empty the tank after use.
- Do not touch hot surfaces. This steamer allows the user to steam fabrics with a large flow of steam. High temperatures are generated during use, which could cause burns. Always position your hands at the handle of the steamer when holding it and warn others (especially children) of the possible dangers of burns from steam, hot water or hot parts, especially when steaming fabrics vertically.
- Allow the steamer to cool completely before storing.
- Store the steamer out of the reach of children.
- When placing the steamer on its base, ensure that the surface on which the base is placed is stable.
- The steamer is not to be used if the steamer has been dropped, if there are visible signs of damage or if it is leaking.
- The steamer is designed for household use and to be used with the tap water. Do not put perfume, vinegar, or other chemicals in the tank. This steamer is not designed to work with these chemicals.
- Do not touch the steam head during use. When using the steamer, make sure the steamer head is facing away from the user and is in an upright position.
- Always test the steamer on a small discreet part of the fabric to be steamed to ensure the temperatures is not too high for the fabric.
- The steamer incorporates a thermal safety fuse to protect the steamer from over-heating. However the steamer should not be left unattended while it is connected to the power outlet. Special care should always be taken when there are children in the home/vicinity of the steamer.

- There may be leakage from the steam head if the steamer temperature is not high enough to vaporize water and create steam. Therefore, ensure that the steamer is always preheated prior to use.
- Never use the steamer while clothes are on the body or direct the steam towards people or animals.
- To protect against electric shock, do not immerse the power cord, power plug or steamer in water or any other liquid or allow moisture to come in contact with the part, unless it is recommended in the cleaning instructions.
- It is recommended to regularly inspect the steamer. To avoid a hazard, do not use the steamer if power cord, power plug or steamer becomes damaged in any way. Return the entire product to the nearest repair service centre for examination and repair.
- The installation of a residual current device (safety switch) is recommended to provide additional safety protection when using electrical appliances. It is advisable that a safety switch with a rated residual operating current not exceeding 30mA be installed in the electrical circuit supplying the appliance. See an electrician for professional advice.
- Do not place this steamer on or near a heat source, such as hot plate, oven or heaters.
- Position the steamer at a minimum distance of 20cm away from walls, curtains and other heat or steam sensitive materials and provide adequate space above and on all sides for air circulation.

Product Description

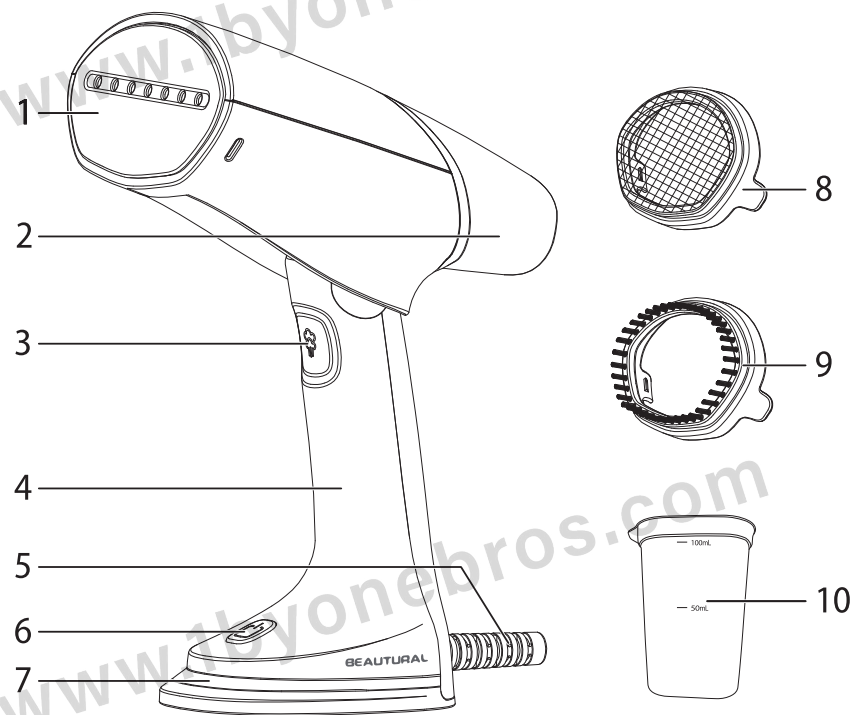

- | | |
|-----------------|-----------------------|
| 1. Steam Head | 6. Power Button |
| 2. Water Tank | 7. Indicator Lamp |
| 3. Steam Button | 8. Soft Cushion Brush |
| 4. Handle | 9. Fabric Brush |
| 5. Power Cord | 10. Measuring Cup |

Included Items

- | | |
|------------------------|---------------------------------|
| 1 x Garment Steamer | 1 x Measuring Cup (3.4oz/100ml) |
| 1 x Soft Cushion Brush | 1 x Instruction Manual |
| 1 x Fabric Brush | |

Before using the Garment Steamer for the first time, check the package contents to ensure all parts are free of visible damage.

Getting Started

- Carefully remove the steamer from package, making sure all of the parts and accessories are free of visible damage. Remove all protective packaging material from the steamer prior to its first use.
- Remove and save the instruction manual.
- Wipe the outside of the steamer with a damp cloth or sponge to remove any dust, then dry thoroughly.
- When using the steamer for the first time, you may notice a small amount of smoke and a slight odor. This is normal when heating the appliance for the first time and there is no reason for concern.

Important Notes

- Using distilled, purified or filtered water is highly recommended to maintain optimal performance. Tap water contains minerals that build up over time.
- Any water droplets visible inside the tank upon unpacking are from individual quality control tests done to ensure every steamer meets our high standards for product performance.
- Do not use perfumes, oils or other additives.
- Always review the garment manufacturer's care label instructions before steaming, and always test fabrics for colorfastness in inconspicuous areas (such as an inseam). Steamers are not recommended for use on leather, suede, vinyl, plastic or other steam-sensitive fabrics.
- During use the steamer and accessories will become hot. Avoid attaching or removing brush attachments while still hot.
- After preheating, prime the water pump by pressing the steam button and then wait as steam forms.
- It is normal to feel or hear the water pump in the handle.
- The water pump may become louder when the water level in the tank is low. Check and refill the tank as needed.

Attaching/Removing Brush Attachments

The steamer comes with two optional-use brush attachments recommended for use with a variety of fabrics and upholstery.

To Attach: While the brush and steamer are cool, gently attach the top of the brush over the top of the steamer head and then press the tabs on both sides of the brush until it snaps into place.

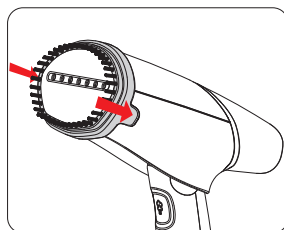

To Remove: Allow the steamer to cool prior to removing the brush. Gently pull on one side of the tab to remove.

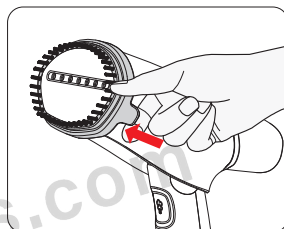

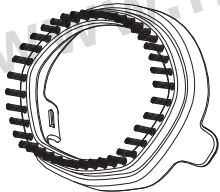
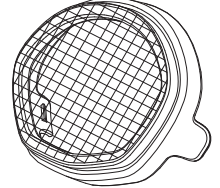
Brush Attachment	Usage
<p>Fabric Brush</p> 	<p>Allows for use of steam to remove lint, pet hair, dust, dirt, dander on overcoat and down jacket.</p>
<p>Soft Cushion Brush</p> 	<p>For use on delicate fabric to soften the steam. Allows for use of steam to dry steam suits, sweaters, wool fabric and plush cloth.</p>

Filling the Water Tank

1. Unfold the steamer. Place the steamer on its base on a stable surface.
2. Hold the handle to stabilize the steamer and lift up the removable water tank with the other hand.

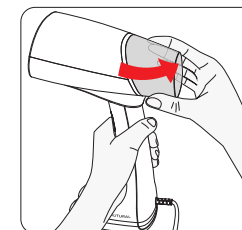

3. Gently pull out the rubber water tank cover at the top of the tank.

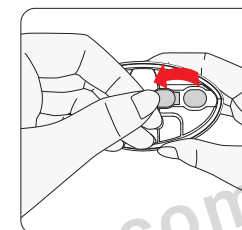

4. Using the included measuring cup, pour water into the opening and then close the rubber cover securely.

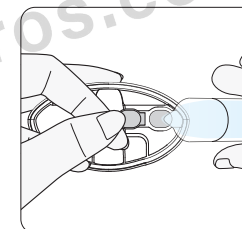

What Water to Use: Using distilled, purified or filtered water is highly recommended and will reduce mineral buildup. Do not use oils, perfumes or scented additives.

5. Dry off any excess water from the tank. Push the water tank back into the steamer until it clicks into place.
6. To refill at any time during use, press the power button to turn the steamer off, unplug from the outlet and follow the above procedures.

Tip: After refilling, allow to reheat for at least 40 seconds and then press the steam button to generate steam.

Using the Steamer

1. Read the manufacturer's fabric label to make sure the fabrics are suitable for steaming.
 - If you see "do not iron," attach the soft cushion brush and make sure to test on an inconspicuous area prior to steaming the entire garment.
 - If you see "do not steam," do not steam the garment.
2. Refer to the "Attaching/Removing Brush Attachments" section for determining whether to use a brush. Attach or remove brushes while the steamer and brushes are cool.
 - Hang the garment in an area that will not be impacted by the heat and steam, such as on a shower rod.
 - This steamer is anti-dripping, meaning it can be used horizontally to steam garments on an ironing board.
3. Plug the steamer into an outlet and then press the power button; the red indicator light will blink, indicating the steamer is heating.

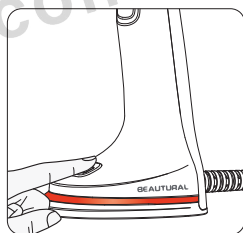

4. After about 40 seconds the indicator light will become solid, indicating the steamer is preheated.
5. To generate steam, press the steam button once ; the indicator light will turn green and steam will emit from the steamer. Press it again to stop the steam.

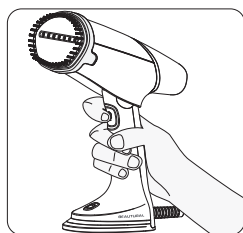

Note: Please press the steam button after the indicator light becomes stable, otherwise, it may cause water to leak from the steamer.

6. Use your free hand to keep the fabric taut and stretched. Steam the garment with slow, downward strokes, keeping the head of the steamer in contact with the fabric.

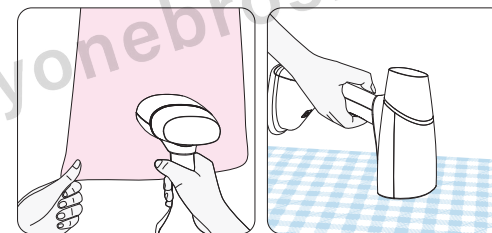

Note: It is normal to feel or hear the water pump in the handle.

7. When finished steaming, press the power button and unplug from the outlet.
8. **Stand the steamer on its base and allow it to completely cool off before storing. To avoid mineral buildup, empty the tank after each use.**

Auto Shutoff

The steamer will automatically switch to auto shut-off mode after being left inactive for 8 minutes. The red and green blinking of the indicator light indicates that the steamer is going into auto shutoff mode. To resume steaming, press the steam button and wait for the steamer to fully reheat.

Steaming Tips

Steaming Garments

1. Place the fabric in a dry and ventilated place and at least 20 cm (8 inches) away from any walls (otherwise moisture may cause mildew).
2. Empty garment pockets and straighten turn-ups such as cuffs and hems.
3. Hang the garment from a hanger and stretch the fabric slightly with one hand, making sure there is nothing behind the fabric that could be damaged by the steam.
4. Put the steam head against the garment and press and move your arm in an up and down motion, targeting creases on the fabric.

Note: Do not steam over metal accessories. Use with caution when steaming around metal accessories.

Steaming Curtains

1. Wash and dry the curtains.
2. Steam when they are hanging.
3. While steaming, stretch the curtains with one hand to help remove creases more easily.

Steaming Upholstery

1. The garment steamer can be used to kill bacteria, remove odors and freshen up furniture upholstery, slip covers and cushions.
2. Move the garment steamer over the fabric. Cushions should be removed for steaming. Allow cushions to dry thoroughly before placing back on furniture.

Maintenance and Care

Cleaning the Steamer Exterior

1. Make sure steamer is off, unplugged and completely cool.
2. Wipe the ironing plate and outer surface with a soft, damp cloth. Water and a small amount of gentle household soap, such as dishwashing liquid, can be used on the exterior. Never use heavy-duty cleaner or abrasive scouring pads that may scratch or discolor the steamer.
3. After the steamer has been thoroughly dried, turn it back on and lightly steam over an old cloth. This will help remove any residue left in the steam holes.
4. When finished cleaning, press the power button to turn off the steamer. Unplug, empty the tank and allow it to cool before storing.

Cleaning Brush Attachments and Accessories

For all accessories, allow to fully dry before using again or storing.

Accessories are not suitable for cleaning in a washing machine.

- **Fabric Brush:** Wipe with a damp cloth to clean.
- **Soft Cushion Brush:** Wash with cold water and small amounts of gentle cleanser if needed. The fabric in the brush should not be removed.

Cleaning Water Tank with Vinegar and Water

It is recommended to clean the water tank every two months to reduce mineral buildup that can affect the performance of the steamer.

1. Remove the water tank, open the rubber water tank cover and fill the water tank with drops of vinegar and water.
2. Shake the water tank for several minutes until the mineral build up has been removed.
3. Rinse the water tank with tap water until the vinegar is eliminated.

⚠ Warning: Do not heat the steamer with vinegar in the water tank, as this will damage the steamer.

Storing the Steamer

Once the steamer has been disconnected from the power outlet, allow it to cool, empty the water from the water tank and clean the tank, fold the steamer and store it in an upright position on a flat surface.

Troubleshooting

Issue	Possible Solution
The steamer does not heat up.	Check that the power plug is inserted correctly.
	Check the power supply.
	Check the power button.
The steamer does not generate steam.	Check the water level and check that the water tank inlet cover is properly closed.
	The steamer has not heated up sufficiently. Let the steamer heat up for about 40 seconds before using it.
Water spills from the water tank.	Make sure the tank is not overfilled.
	Make sure the water tank inlet cover is properly closed.
The steamer is producing a loud humming or pumping sound.	Check the water level. If there is no water or the water level is low, refill the water tank.
The steamer does not seem to remove creases easily.	For more difficult wrinkles, try steaming from the underside of the fabric.
Unsure when to use the soft cushion brush.	Use when steaming is touching the fabric too directly.
	When steaming delicate fabric, such as silk so as to reduce the risk of water dripping onto the garment while steaming.
Avoiding discoloring of metal accessories on the garment.	Do not directly hover the steamer over the metal accessories.
	Use caution and steam around the metal accessories.

Specifications

Model: 722NA-0014, HJ-3008

Rated Voltage: AC 100-120V/220-240V~ 50/60Hz

Rated Power: 830-1100W/900-1100W

Water tank capacity: 100ml (3.4 fl.oz)

Disposal

Disposal of the appliance



Under no circumstances should you dispose of the appliance in normal domestic waste. This product is subject to the provisions of European Directive 2012/19/EU.

Dispose of the appliance via an approved disposal company or your municipal waste facility. Please observe currently applicable regulations. Please contact your waste disposal center if you need any further information.



The appliance's packaging is made from environmentally friendly material and can be disposed of at your local recycling plant.

Customer Service

UNITED STATES	Phone: +1 909-391-3888 (Mon-Fri 9:00am - 5:00pm PST) Email: ushelp@1byonebros.com
CANADA	Email: cahelp@1byonebros.com
UNITED KINGDOM	Email: ukhelp@1byonebros.com
GERMANY/FRANCE ITALY/SPAIN	Email: euhelp@1byonebros.com

BRAND OWNER

1byone Products Inc.

1230 E Belmont Street, Ontario, CA, USA 91761

Customer Service: +1 909-391-3888

www.1byonebros.com