



## HIGH FIDELITY BELT DRIVE TURNTABLE



1byone Products Inc.  
1230 E Belmont Street, Ontario, CA, USA 91761  
Customer Service: +1 909-391-3888  
[www.1byonebros.com](http://www.1byonebros.com)

Made in China

**Instruction Manual**



## Introduction

Thank you for purchasing the 1byone Integrated Turntable for Vinyl Record. This instruction manual contains important information about its safety, usage and disposal. Use the product as described and keep this manual for future reference. If you sell this turntable or pass it on, please also give this manual to the new owner.

## Safety Instruction

1. Please use the appliance as instructed.
2. DO NOT expose the appliance to rain, moisture, dripping or splashing of water.
3. Ensure the power supply voltage matches the voltage indicated on the product.
4. DO NOT retrofit the plug yourself in any way.
5. DO NOT pull, bend, step on or compress the power cord.
6. Assemble the product as instructed, and DO NOT place any objects on the product.
7. Avoid dropping any objects or splashing any liquid into the appliance, for they may contact with dangerous voltage points or cause component short circuits, leading to fire or electric shock.
8. DO NOT attempt to repair the appliance or try to remove the casing panel yourself. All maintenance work should be left to qualified service personnel.
9. DO NOT use turntable replacement parts or components with this product that are not approved by the manufacturer.
10. DO NOT place the appliance anywhere near high temperature or open flame.
11. Place the product on a flat and stable surface; extra caution should be paid to prevent tipping or collision during moving or handling. 
12. The slots and openings on the body of the machine are designed to ensure ventilation and reliable operation of the product, preventing overheating. DO NOT block or cover these openings.
13. Unplug the product during thunderstorm or the product is not in use for extended periods.

## Compliance with FCC Regulation

This device complies with Part 15 of FCC rules. Operation is subject to the following two conditions:

- (1) This device may not cause harmful interference, and
- (2) This device must accept any interference received, including interference that may cause undesired operation.

This equipment has been tested and found to comply with the limits for a Class B digital device, pursuant to Part 15 of the FCC rules. These limits are designed to provide reasonable protection against harmful interference in a residential installation.

This equipment generates, uses and can radiate radio frequency energy and, if not installed and used in accordance with the instructions, may cause harmful interference to radio communications. However, there is no guarantee that interference will not occur in a particular installation.

If this equipment does cause harmful interference to radio or television reception, which can be determined by turning the equipment off and on, the user is encouraged to try to correct the interference by one or more of the following measures:

- Reorient or relocate the receiving antenna.
- Increase the separation between the equipment and receiver.
- Connect the equipment into an outlet on a circuit different from that to which the receiver is connected.
- Consult the dealer or an experienced radio/TV technician for help.

RF Exposure Statement:

When using the product, maintain a distance of 20cm from the body to ensure compliance with RF exposure requirements.

**WARNING:** Changes or modifications to this unit not expressly approved by the party responsible for compliance could void the user's authority to operate the equipment.

**WARNING:** Cancer and Reproductive Harm - <http://www.P65Warnings.ca.gov>  
For more information go to <http://www.1byonebros.com/Compliance/Prop65>

## Product Description

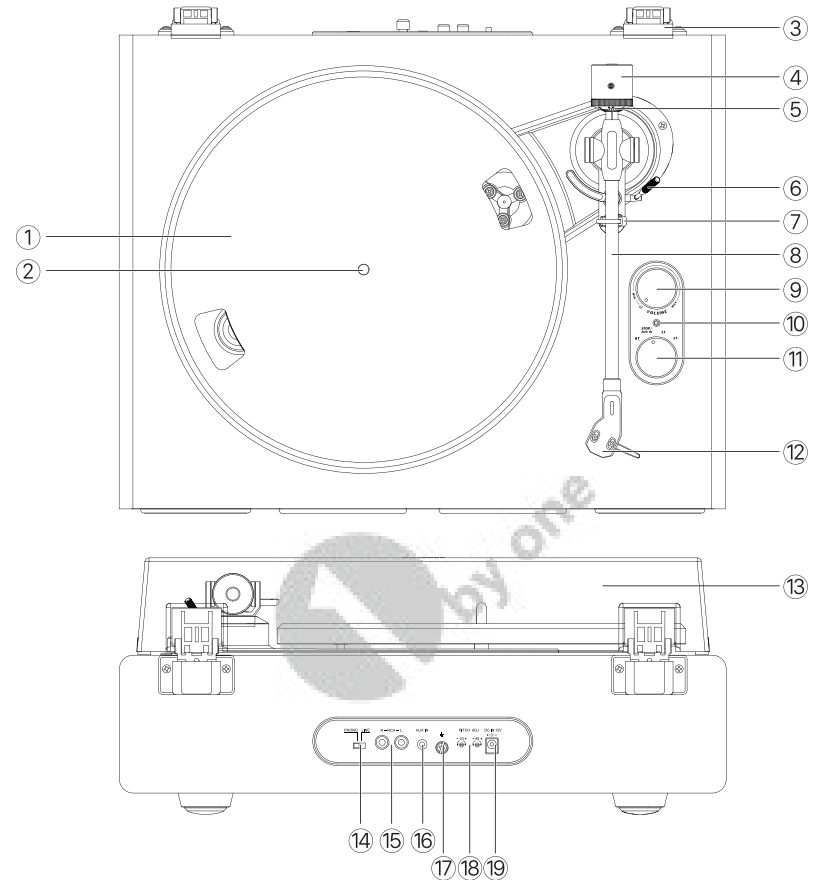

1. Turntable Platter
2. Turntable Spindle
3. Lid Hinge
4. Counterweight
5. Tracking Force Dial
6. Tonearm Lift Lever
7. Tonearm Clip
8. Tonearm
9. Power/Volume Knob

10. Indicator Light
11. Function Knob
12. Stylus
13. Turntable Lid
14. Phone/Line Out Switch
15. Audio Output Jack
16. Audio Input Jack
17. Ground Terminal
18. Speed Adjustment Screw
19. Power Input Jack

## Included Items

Before installing the turntable, check the package contents to ensure all parts below are included and free of visible damage. Please retain the original packaging materials for exchange or return purposes.

- |                                |                                   |
|--------------------------------|-----------------------------------|
| 1) Turntable Unit              | 6) Counterweight                  |
| 2) Power Adapter               | 7) Cartridge Alignment Protractor |
| 3) Turntable Lid               | 8) 45 RPM Adapter                 |
| 4) Slip Mat                    | 9) Instruction Manual             |
| 5) Turntable Platter with Belt |                                   |

## Installing the Turntable

- Mount the turntable on a level surface.
- To avoid the effects of vibrations and acoustic pressure, do not mount the turntable next to items such as speakers.
- The turntable may pick up radio static if placed next to a radio. Therefore, try to keep the turntable away from transmission devices such as radios.
- If the turntable is near equipment (cell phone, etc.) that emits strong radio waves, noise may occur.

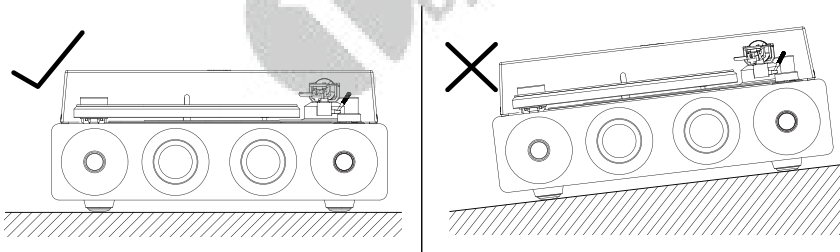

## Turntable Platter and Belt Setup

1. Turn the platter over and check the belt position.
  - Make sure that the drive belt is looped in the middle of the circle. The drive belt located too high or too low in this circle may cause the drive belt to fall off or speed to be unstable.

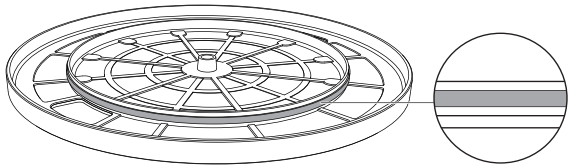

4

2. Set the platter on the spindle.
  - Make sure the platter is fully seated on the spindle.

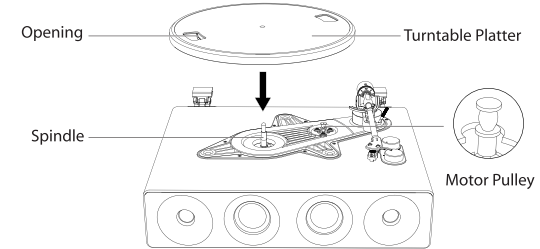

3. Place the belt on the motor pulley.
  - Align one of the platter openings with the motor pulley, and while pulling both ends of the red ribbon that comes attached to the belt, place the belt on the motor pulley, as per the diagram. When doing this, be careful not to twist the belt.

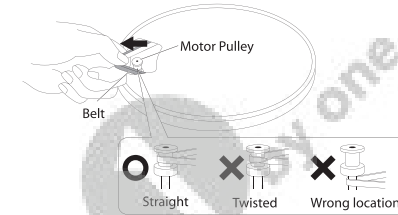

4. Manually rotate the Turntable Platter ten times in a clockwise direction.
  - Check if the belt is twisted or detached to ensure the smooth operation of the Turntable Platter.

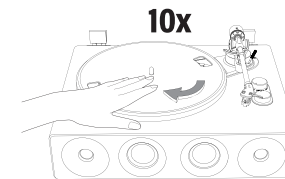

5. Place the Slip Mat on top of the platter. place the **by one** logo on the mat is facing up.

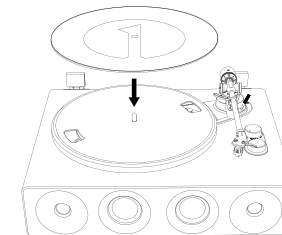

5

## Cartridge Tracking Force Adjustment

The supplied Counterweight is suitable for cartridges weighing between **2.5g - 3.5g**

1. Gently push and turn the Counterweight onto the rear of the Tonearm (with the dial facing toward the front of the turntable).

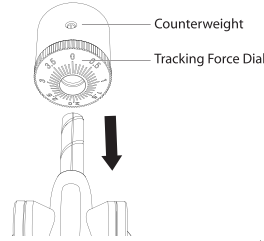

2. Pull the Stylus Protector straight forward horizontally to remove it.

**Note:** Applying a downward force to remove the protector may cause the Stylus to come off the body. If the Stylus was about to come off or already come off, only a faint sound will be produced. In such case, consult the section on "Replacing the Stylus" to ensure the Stylus is reattached properly.

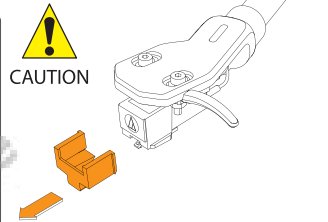

3. Remove the tie-wrap and unlock the Tonearm.

4. Lower the Tonearm lift lever and position the cartridge in the space between the tonearm rest and platter, and then press the Tonearm Lift Lever.

5. Carefully rotate the Counterweight until the Tonearm achieves a neutral balance. The Tonearm should return to this balanced position after a slight sway if it is accidentally touched.

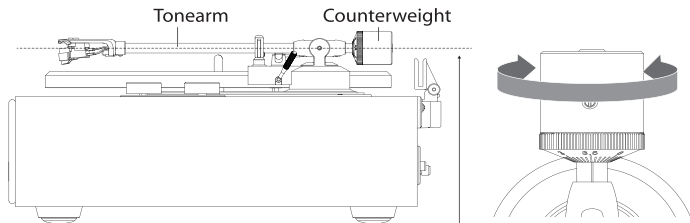

Adjust the counterweight until the tonearm achieves horizontal balance.

6. After achieving tonearm balance, gently position it onto its rest and secure it. Hold the Counterweight steady with one hand while rotating the tracking force dial with the other to align the "0" mark with the dial's centerline. Once this is done, release the Tonearm to verify that it maintains its horizontal balance.

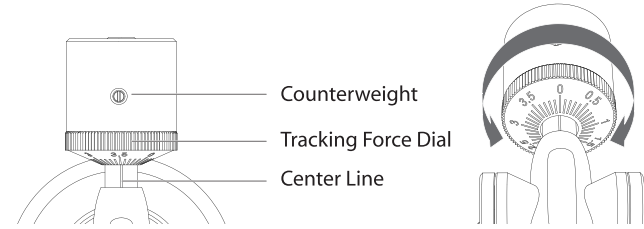

7. Finally, rotate the Counterweight counterclockwise (viewed from the front) until the recommended tracking force value **2.5** aligns with the tracking force calibration center line.

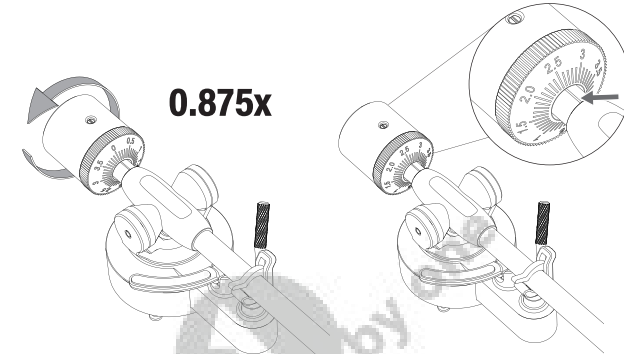

**Note:** Each mark on the dial represents 0.1g. The recommended tracking force for the factory-installed cartridge is 2.5g. Carefully rotate the Counterweight to the 2.5 mark, and then align it with the center line.

## Installing the Lid

Align the hinge catch of the lid with the lid hinge on the back of the unit, and then press the dust cover into place.

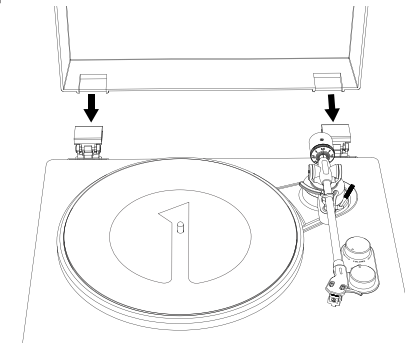

## Connection to External Speaker with RCA Audio Cable

This turntable includes four built-in speakers and one built-in phono equalizer. If you wish to use your own amplifier or speakers, please follow the instructions below:

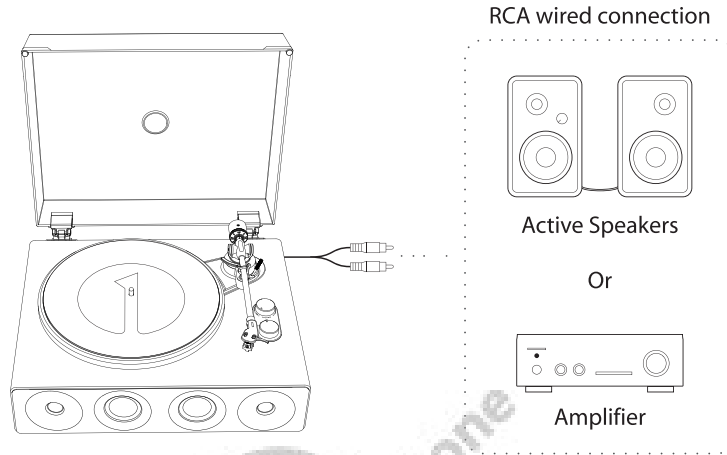

**Note:** In order to achieve the best sound, it is advised to set the turntable volume to a minimal level. Then the turntable's audio will be played back through your own amplifier, speakers, etc.

### 1. Setting Pre-amplifier Selector Switch

This product has a built-in phono equalizer function. You can use the product even if you do not have a phono amplifier or connectable equipment with a built-in phono amplifier.

Use the Phono & Line Out Switch to set the output, as shown below.

Connectable equipment being used	Position of the Phono & Line Out Switch	Where to connect RCA audio cable
Device with phono input	PHONO	Phono input jack and ground (earth) terminal of connected equipment
Device without phono input	LINE	AUX or line input jack of connected equipment

**Note:** The RCA Jacks are not designed to be connected directly to the passive/unpowered speakers on LINE mode. If connected to the passive speakers, there will be no sound.

### 2. Connecting the Device

Align the settings for the Phono & Line Out Switch and connect the RCA audio cable to an input jack that is compatible with the connectable equipment you are using (amplifier, active speakers, etc.).

- **The RCA audio cable's red jack is for the right (R) channel, and the white jack is for the left (L) channel.**

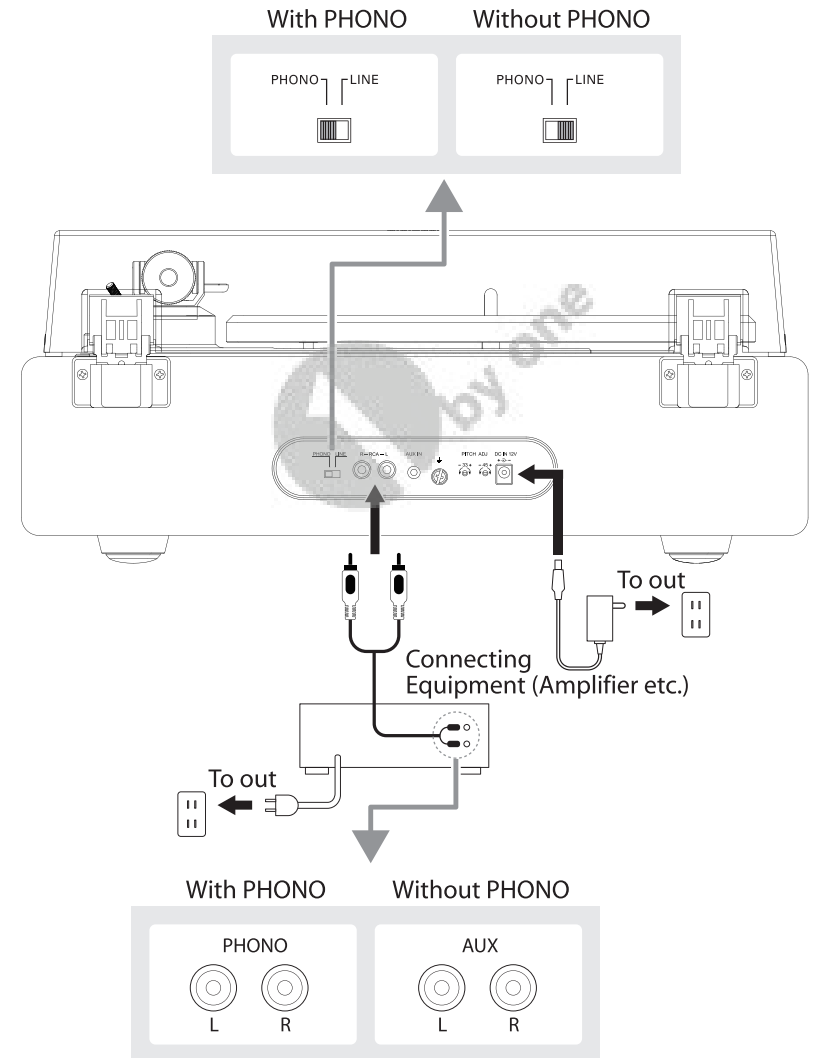

## Main Power Connection

1. Insert the DC plug of AC adapter cord to the DC INPUT JACK at the back of the turntable.
2. Plug the AC adapter into a normal power outlet.

**Note:** DO NOT plug the AC power adapter into a power outlet before all turntable assembly is completed. Before turning on turntable power, recheck all connections to make sure they are correct and secure. Always turn off the turntable before connecting or disconnecting from power.

## Playing a Record

### 1. Before playing a record

- 1.1 Pull the protector straight forward to remove it.

**Note:** Applying a downward force may cause the stylus come off the body. If the Stylus was about to come off or already come off, only a faint sound will be produced. In such case, refer to "Replacing the stylus" to reattach the stylus correctly.

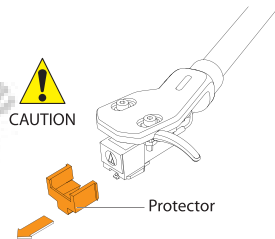

- 1.2 Place the record on the felt mat so that the center hole aligns with the spindle.

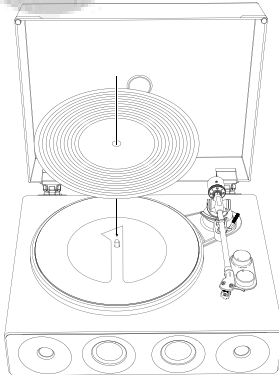

### 2. Turntable Operation

Sufficiently lower the volume of the amplifier and speakers first.

- 2.1 Attach the included power adapter to the turntable, set the Power/Volume Knob to "MIN", and wait for a "click" sound and illuminated red indicator light to confirm the device is activated.

- 2.2 Remove the stylus protector from the stylus.
- 2.3 Place the record on the slip mat. For 45RPM vinyl records, ensure that the provided 45RPM adapter is properly seated on the turntable's spindle before playback.
- 2.4 Rotate the Function Knob to switch between 33 and 45 RPM speeds according to the record type, and then the turntable will begin spinning clockwise.
- 2.5 Release the Tonearm, and ensure the Tonearm lifter is in the raised position before playing the record.
- 2.6 Position the Tonearm over the desired location (notch) on the record.
- 2.7 Carefully lower the Tonearm on the record.
- 2.8 Adjust the turntable's volume to the desired level.
- 2.9 When finish playing the record, lift the Tonearm lifter, return the Tonearm to its rest, and secure it. Rotate the Function Knob to "STOP/AUX IN" to stop the turntable, and then rotate the Power/Volume Knob to "⏻" to turn off the machine. Meanwhile, all indicator lights will shut off.

#### Note:

1. If the silent pause time between each track is longer than 3 minutes, the platter will stop spinning automatically to avoid damaging the record. The indicator light will turn red. To resume operation, rotate the Power/Volume Knob off and then on again.
2. If the felt mat gets dirty, it can easily scratch the record, so remove the felt mat periodically and wipe off any dust.
3. To prevent the record from getting scratched and warping, remove it after use.
4. Do not use a disk stabilizer.

## Bluetooth Operation

1. Attach the included power adapter to the turntable, set the Power/Volume Knob to "MIN", and wait for a "click" sound and illuminated red indicator light to confirm the device is activated.
2. Rotate the Function Knob to Bluetooth mode. The indicator light will illuminate blue and flash rapidly.
3. Turn on the Bluetooth function of your media device, search and select "1byone LP03" to pair the media device with the turntable.
4. Once the turntable is successfully paired with your media device, the Bluetooth indicator light will be stabilized.
5. Play and stream music from your media device.

**Note: Bluetooth version, 5.4**

## AUX-IN Operation

This turntable includes an auxiliary audio signal input jack for connecting external audio devices like MP3 players, CD players, and older, non-dockable iPods so you can listen to your external source through the turntable's speakers.

1. Use an audio cable (not included) with one 3.5 mm stereo connection on each end of the cable.
2. Plug one end into the AUX-IN jack on the turntable and the other end to the Line Output jack of the audio device.
3. Power on the turntable and audio device, rotate the Power/Volume Knob to "MIN", and wait for a "click" to confirm it is powered on. Then rotate the Function Knob to "STOP/AUX IN" to activate AUX IN mode. Meanwhile, if the 3.5 mm audio cable is correctly plugged in, the indicator light will illuminate mauve.
4. Adjustment of volume can be done via the Power/Volume Knob of the turntable, and all functions of the auxiliary device operate as usual.
5. Please note that the AUX-IN mode has the highest priority. When AUX-IN mode is in use, you cannot play records or use Bluetooth function. Disconnect the AUX-IN cable before using other functions.

### Note:

1. After used, ensure the tonearm is back to its rest and securely locked to prevent any damage.
2. After using the appliance, don't forget to power off the turntable and your external device.

## Maintenance

### Exterior Body Maintenance

- When the turntable body is dirty or dusty, first disconnect the AC adapter and then wipe off the dirt and dust with a soft, dry cloth.
- DO NOT use benzol, thinners, etc.
- When storing the product for a long time, disconnect the AC adapter from the outlet and wrap the product for storage. DO NOT allow the product or packaging to be damp. The drive belt should be removed to prevent unequal stretching.

### Cleaning the Stylus

- When the stylus becomes dirty or dusty, please clean it with a soft brush.
- It is recommended to use a stylus-specific cleaner (not included) to clean the stylus. Carefully remove dust from the base of the stylus tip towards the tip.

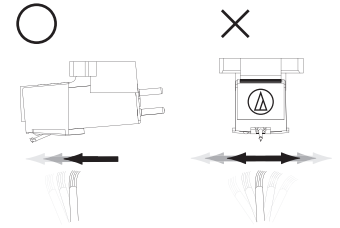

### Replacing the Stylus

It's suggested to replace the stylus after 400 hours use.

### Removing the Stylus

In addition to the deterioration of sound quality, records may also be damaged as the cartridge's stylus tip wears down.

- Be sure to disconnect the product's AC adapter from the outlet.
- When replacing the stylus, hold the headshell and the cartridge body tightly.

Rotate the front of the stylus in a forward and down motion.

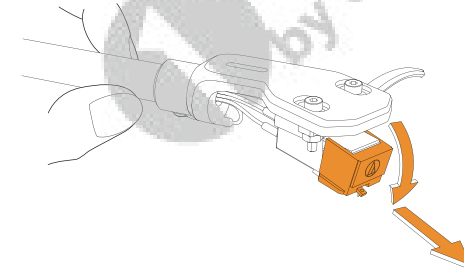

### Installing a New Replacement Stylus

1. Mount the new replacement stylus to the cartridge.

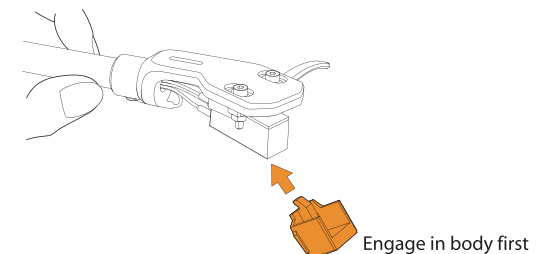



2. Lift the stylus up until a click is heard.

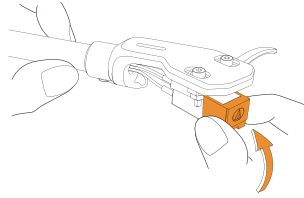

3. Make sure there is no gap between the headshell and the cartridge.

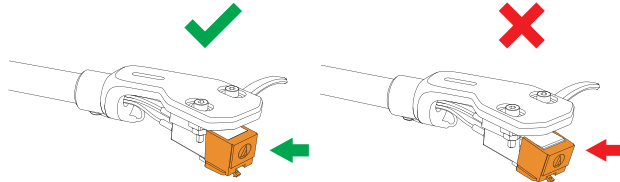

## Replacing the Belt

- The belt is a consumable part. Replace the belt if the playback speed slows down or irregular rotation occurs. **Usually, it's recommended to replace the belt annually.**
- Before replacing the belt, it's necessary to disconnect the AC adapter.

### 1. Remove the Slip Mat

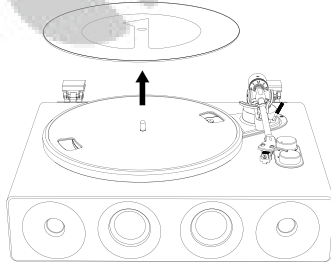

### 2. Remove the belt from the motor pulley.

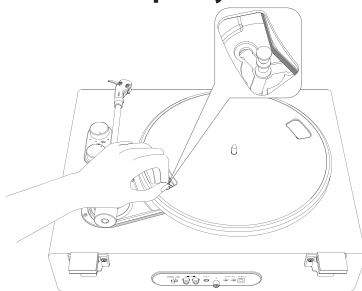

### 3. Remove the main platter and then remove the old belt.

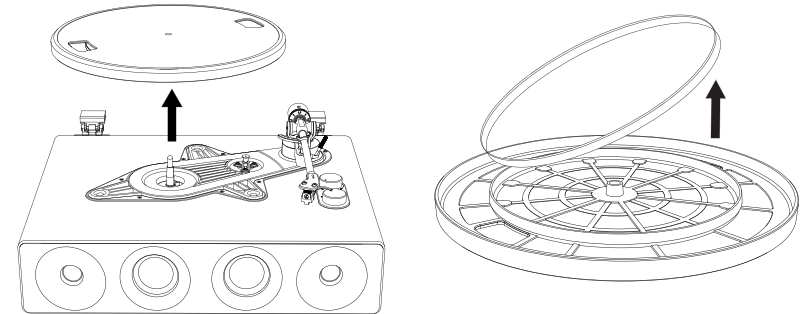

### 4. Turn the platter over and you will see a raised circle. Loop the new belt along the middle circle.

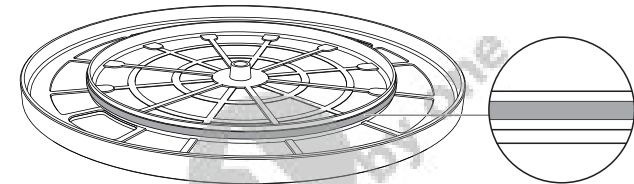

### 5. Attach the platter.

Mount one of the openings on the turntable with the motor pulley.

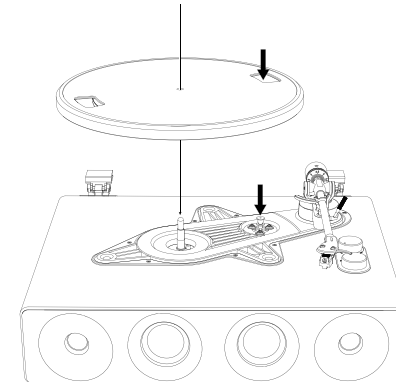

## 6. Place the belt on the brass-colored motor pulley

Hold the belt and slide it onto the notch of the brass motor pulley.

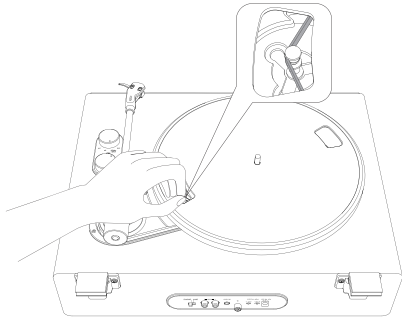

## 7. Use your hand, slowly rotate the platter ten times clockwise as shown below.

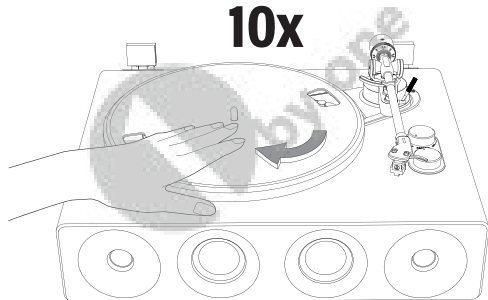

## When moving the Turntable

Pack the product using the original packaging materials, following the original arrangement. If you do not have the packaging materials, please take the following measures:

- Disconnect the power adapter from the socket, remove the anti-slip mat and platter, and then wrap them to prevent damage.
- Place the stylus protection cover on.
- Secure the tonearm to the rest of the unit with a cord or similar item to prevent it from falling off during the moving process.
- Wrap the turntable body with paper or soft cloth to avoid damage.

## Troubleshooting

Problem	Solution
The platter does not spin.	<ul style="list-style-type: none"> <li>• Is the power adapter connected to the socket? <ul style="list-style-type: none"> <li>-Please ensure the power adapter is properly connected to the power outlet.</li> </ul> </li> <li>• What is the status of the indicator light? <ul style="list-style-type: none"> <li>-If the indicator light is not on, please follow the operating steps to turn on the device correctly. After turning on the power, select the appropriate speed to start the turntable.</li> <li>-If the indicator light is blue, this means the turntable is in Bluetooth mode. Please turn the function knob to switch to record playing mode.</li> </ul> </li> <li>• Is the belt detached or damaged? <ul style="list-style-type: none"> <li>-Please check the belt condition and ensure it is properly installed. If damaged, replace it with a new belt.</li> </ul> </li> <li>• Is the AUX-IN audio cable plugged in? <ul style="list-style-type: none"> <li>-The AUX-IN function has the highest priority. Please disconnect the AUX-IN audio cable before playing records or using Bluetooth functions.</li> </ul> </li> <li>• Is the motor working? <ul style="list-style-type: none"> <li>-If installation and operation are correct, please check if the motor pulley is rotating.</li> </ul> </li> <li>• Is the AUX-IN cable plugged in? <ul style="list-style-type: none"> <li>-AUX-IN function is a first-priority function. Please unplug the AUX-IN cable before using the PHONO/BT functions.</li> </ul> </li> </ul>
Turntable spinning, but no sound or only low volume from the turntable.	<ul style="list-style-type: none"> <li>• Are there any mistakes in wiring connections and function settings? <ul style="list-style-type: none"> <li>-Ensure that the PHONO/LINE switch on the vinyl record player matches the type of input jack on the audio device it is connected to.</li> <li>-Check the wiring connections between the record player and the audio device, as well as the device's functions and volume settings.</li> </ul> </li> <li>• Is the stylus damaged? <ul style="list-style-type: none"> <li>-Replace the stylus if necessary, and it is recommended to replace the stylus every 400 hours of use.</li> </ul> </li> <li>• Is the stylus correctly installed on the cartridge base? <ul style="list-style-type: none"> <li>-Check that the stylus and cartridge are correctly installed.</li> </ul> </li> </ul>

Sound skip occurs.	<ul style="list-style-type: none"> <li>• Is the record warped? - Check the record.</li> <li>• Is the record scratched? - Check the record.</li> <li>• Is the stylus pressure correct? - Refer to "Cartridge Tracking Force Adjustment" to readjust the tracking force.</li> </ul>
Strange noises from the turntable.	<ul style="list-style-type: none"> <li>• Is the product absorbing vibrations from the ground, walls, or nearby speakers? -Reduce environmental vibrations or install the product on a surface that is less susceptible to vibrations.</li> <li>• Is the product installed on an unstable surface? -Ensure the product is placed on a stable surface.</li> </ul>
Noise during record playback.	<ul style="list-style-type: none"> <li>• Is there dust accumulated on the stylus tip? -Clean the stylus with a professional cleaning brush.</li> <li>• Are there dust or scratches on the vinyl record? -Clean the surface with commercial record cleaning products, or replace the vinyl record.</li> <li>• Is the tracking force correct? -Refer to the manual to adjust the cartridge tracking force correctly.</li> </ul>
Music playback is slow or uneven.	<ul style="list-style-type: none"> <li>• Is the belt installed correctly? -Refer to the manual for belt installation instructions.</li> <li>• Is the belt excessively stretched? -Replace with a new belt.</li> </ul>
Record playback speed is too fast or too slow.	<ul style="list-style-type: none"> <li>• Is the turntable's speed setting correct? -Select the correct speed based on the type of record being played.</li> <li>• Is the speed still abnormal? -Adjust the speed using the fine-tuning screw on the back of the turntable.</li> </ul>
Tonearm does not automatically move to the record for playback or return to its rest after playback.	-This turntable is not an automatic model; you will need to manually move the tonearm over the record or secure it back to the rest.
The stylus cannot touch the record.	-The tonearm is too high; turn the screw on the Tonearm Lift Lever clockwise to lower the stylus height.
The stylus is scraping the record severely.	-The tonearm is too low; turn the screw on the Tonearm Lift Lever counterclockwise to raise the stylus height.

**Note:** The tightness of the factory screws is determined by the thickness of the included Slip Mat. If you use a different Slip Mat that is thinner or thicker, please adjust the screws according to the troubleshooting steps for the last two issues.

## Speed-Fine Tuning Screw

Please adjust the speed fine-tuning screw only after ruling out other issues affecting the turntable's speed. Power on the turntable, select either 33 RPM or 45 RPM, and while the platter is spinning, locate the speed fine-tuning screw on the back of the turntable. Use a flat-head screwdriver to carefully turn and adjust the corresponding screw to modify the speed.



## Specifications

### Turntable

Model	1-AD07US15
Power Adapter	Input AC100-240V, Output DC12V 2A
Maximum Power Consumption	24W
Speed	33 1/3, 45RPM
Amplifier (RMS)	4Ω 18Wx2 (BT), 5Wx2 (PH)
Dimensions (LxWxH)	Closed size 440x345x190mm Open size 440x345x370mm
Net Weight	5.8kg

## Cartridge

Model	Audio-Technica AT3600
Frequency Response	20Hz-20kHz
Channel Balance	<2.5dB
Channel Separation	>18dB
Output Voltage	2.5mV
Recommended Load Resistance	47kΩ
Amplifier Connection Type	MM (Moving Magnet)-input
Recommended Cartridge Tracking Force	2.5±0.5g
Weight	0.18oz (5.1g)

**Note: Design and specifications are subject to change without notice.**

## Disposal

### Disposal of the Product



Under no circumstances should you dispose of this product in normal domestic waste.

This product is subject to the provisions of European Directive 2012/19/EU.

Dispose of this product via an approved disposal company or your municipal waste facility. Please observe currently applicable regulations.

Please contact your waste disposal center if you need any further information.



This product's packaging is made from environmentally friendly material and can be disposed of at your local recycling plant.

## Customer Service

<b>UNITED KINGDOM</b>	Email: <a href="mailto:ukhelp@1byonebros.com">ukhelp@1byonebros.com</a>
<b>CANADA</b>	Email: <a href="mailto:cahelp@1byonebros.com">cahelp@1byonebros.com</a>
<b>UNITED STATES</b>	Phone: +1 909-391-3888 (Mon-Fri 9:00am - 5:00pm PST) Email: <a href="mailto:ushelp@1byonebros.com">ushelp@1byonebros.com</a>
<b>GERMANY/FRANCE ITALY/SPAIN</b>	Email: <a href="mailto:euhelp@1byonebros.com">euhelp@1byonebros.com</a>

### BRAND OWNER

1byone Products Inc.

1230 E Belmont Street, Ontario, CA, USA 91761

Customer Service: +1 909-391-3888

[www.1byonebros.com](http://www.1byonebros.com)