

**BEAUTURAL**

## **Travel Steam Iron**



1byone Products Inc.  
1230 E Belmont Street, Ontario, CA, USA 91761  
Customer Service: +1 909-391-3888  
[www.1byonebros.com](http://www.1byonebros.com)

Made in China

Instruction Manual

## **Introduction**

Thank you for purchasing the BEAUTURAL Travel Steam Iron. This instruction manual contains important information about its safety, usage, and disposal. Use the product as described and keep this manual for future reference. If you sell this iron or pass it on, please also give this manual to the new owner.

## **Safety Instructions**

READ ALL INSTRUCTIONS BEFORE USE AND RETAIN FOR FUTURE REFERENCE

- This appliance is for light or occasional indoor/household use only. This iron is not intended for professional laundry services.
- The Steam On/Off Switch should always be turned to "OFF" before plugging or unplugging the unit from the outlet. Never yank the cord to disconnect from the outlet; instead, grasp the plug and pull to disconnect.
- Always disconnect the iron from the electrical outlet when filling with water or emptying, and also when not in use.
- To protect against a risk of electric shock, do not operate this product with wet hands, spill liquid on the appliance or submerge it in water or any other liquid.
- This appliance can be used by children aged from 8 years and above and persons with reduced physical, sensory or mental capabilities or lack of experience and knowledge if they have been given supervision or instruction concerning the use of the appliance in a safe way and understand the hazards involved. Children shall not play

with the appliance. Cleaning and user maintenance shall not be made by children without supervision.

- Please ensure the main power supply is 100-125V~ 50/60Hz, or 220-240V~ 50/60Hz.
- Do not operate the iron if the power cord is damaged or if the iron has been dropped or damaged. To avoid a risk of electric shock, do not disassemble the iron. Take it to a qualified service person for examination and repair, or contact our customer service. Incorrect reassembly can cause a risk of electric shock when the iron is used.
- Never try to replace the parts or repair the appliance by yourself.
- Do not use an extension cord to operate this unit.
- To reduce the likelihood of circuit overload, DO NOT operate another high-wattage appliance on the same circuit as this unit.
- Do not place the appliance on or near a hot gas or on a heated oven.
- Do not let the power cable hang over the edge of a table or counter or touch a hot surface. Let the iron cool completely before putting away.
- Pay close attention to the iron while in use. The iron must not be left unattended while it is connected to the main socket.
- Do not use any attachments which are not listed in this manual.
- Keep the hot soleplate away from body parts and heat-sensitive objects.
- Keep the appliance well away from surfaces and objects that can be damaged by heat.

- Burns can occur from touching hot metal parts, hot water, or steam. Always hold the iron by the handle. Do not touch the soleplate while the unit is in use.
- Do not turn the unit upside down - hot water may drip out from holes on Water Tank Windows.
- To reduce the risk of contact with hot water emitting from steam vents, check the appliance before each use by positioning it away from the body and setting the steam On/Off Switch.
- Do not leave water in the water tank when iron is not in use - this can corrode and damage the soleplate.
- Ensure there is adequate space to operate the iron.
- Use this iron only with a purpose-built ironing board.
- Observe all of the ironing instructions and ironing temperature dot settings given by the garment manufacturer. These guidelines are normally on the label/s inside the garment.
- Always ensure the water filling does not exceed the MAX mark on the water inlet.
- Do not iron buttons or fasteners. This could damage the iron.
- Do not iron directly onto synthetic fabric - instead iron the fabric inside out or with the synthetic fabric covered by other material to protect it.

## Product Description

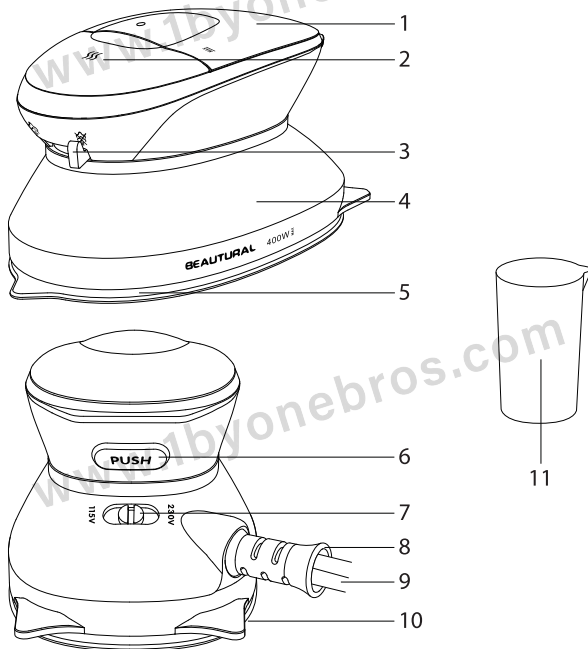

- |                            |                     |
|----------------------------|---------------------|
| 1. Water Tank              | 7. Voltage Selector |
| 2. Heating Indicator Light | 8. Cord Guard       |
| 3. Steam On/Off Switch     | 9. Power Cord       |
| 4. Main Body               | 10. Heel Rest       |
| 5. Soleplate               | 11. Measuring Cup   |
| 6. PUSH Button             |                     |

Product may vary slightly from what is illustrated.

## Before Use

### Setting the Voltage

The BEAUTURAL Travel Steam Iron features dual-voltage functionality, which allows it to function correctly in regions with either 100-125V or 220-240V electrical voltage standards. Voltage is set using the Voltage Selector.

For use in Canada or North America, the voltage selector switch should be placed in the 115V position. For use in most other countries, the selector switch must be placed in the 230V position. **CONFIRM the voltage available at each location before using the iron.**

**NOTE:** For connection to a 230-volt supply an adaptor plug may be needed.

**IMPORTANT:** By default, the Voltage Selector is set to the 100-125V setting. Be sure to select the correct voltage for your location before plugging the power cord into an electrical outlet.

### Filling the Water Tank

Only fill the iron with water if you intend to use the steam function. For dry ironing, you do not need to fill the tank with water.

1. Unplug the unit and make sure the Steam ON/OFF Switch is off. (slide the switch to the "☒" position as shown in FIGURE 5)

2. Press the PUSH Button to remove the Water Tank.  
(FIGURE 1)

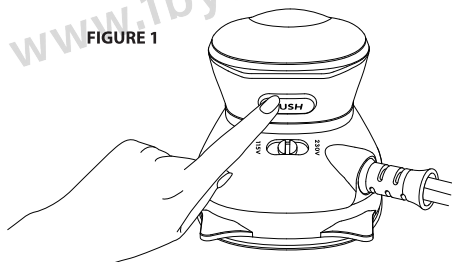

3. Fill the Measuring Cup with clean water.

**NOTE:** In order to extend the life of your unit and keep it functioning at its maximum potential, it is highly recommended to use distilled, purified, or filtered water. Avoid using water containing softeners, perfumes, or additives.

4. Open the water inlet cap and slowly pour water into the water tank to the Max level (FIGURE 2). Do not overfill. Firmly close the cap to prevent leakage.

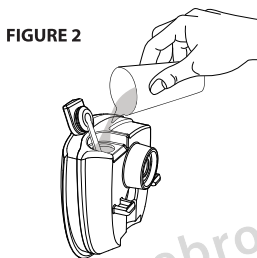

5. Push the water tank back into place.

## Operating the Unit

**IMPORTANT:** Make sure that the Steam On/Off Switch is off (slide the switch to the "☒" position as shown in FIGURE 5) before plugging in or unplugging the unit; toggle it on only when the steam function is in use and be sure the iron is preheated (Heating Indicator Light is off).

**WARNING:** Burns can occur by touching hot metal parts, water, or steam. **DO NOT** touch the soleplate while the unit is in use or not cooled down completely.

### NOTE:

- The iron may give off a small amount of smoke and emit a slight odor when first used. This will cease after a short while. It is safe and will not harm the performance of the iron.
- Always review the garment manufacturer's care label instructions to make sure the fabrics are suitable for ironing. If unsure of a garment's fiber, test a small area (on an inside seam or hem) before ironing.
- Keep the iron well away from surfaces and objects that can be damaged by heat.

## Dry Ironing

**WARNING:** To iron without steam, ALWAYS make sure the Steam ON/OFF Switch is off. (slide the switch to the "☒" position as shown in FIGURE 5)

1. Plug the power cord into a convenient electrical outlet.

2. Wait for the preheating to be finished. The unit is ready for use when the heating indicator light goes off. (FIGURE 3)

FIGURE 3

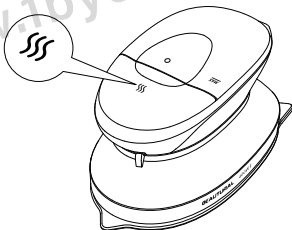

**NOTE:** During use, the Heating Indicator Light will cycle on and off as the unit works to maintain a constant temperature. You may continue to iron while the light cycles.

3. Always stand the iron on its Heel Rest when powered on but not in use. (FIGURE 4)

FIGURE 4

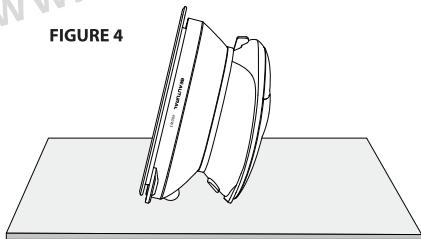

### Steam Ironing

1. Plug the power cord into a convenient electrical outlet.
2. For steam ironing, make sure the water tank is filled to the Max level. Do not overfill.

3. Wait for the preheating to be finished until the heating indicator light goes off.
4. After the unit is preheated, slide the Steam ON/OFF Switch to the "☁" position (FIGURE 6). Hold the iron horizontally for a few seconds and the unit will begin emitting steam from the steam vents on the soleplate.

**NOTE:** This unit is designed to steam horizontally. The steam flow will stop whenever the unit is in a vertical upright position.

5. To stop the steam flow, slide the Steam ON/OFF Switch to the "☁" position (FIGURE 5).

FIGURE 5

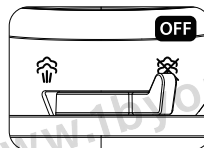
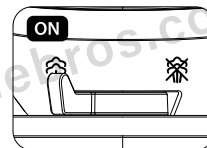

FIGURE 6



6. Always stand the iron on its heel rest when powered on but not in use.
7. If the water level goes low while ironing, unplug the iron and refill it using the measuring cup provided. Be careful and do not touch the hot soleplate.

**Once all ironing tasks are finished, immediately slide the Steam ON/OFF Switch to the "☁" position (FIGURE 5). This will prevent water from accidentally dripping during the next use.**

**NOTE:** It is recommended to empty the water tank after each use for clean steam and to avoid scale deposits. This will prolong the iron's lifespan.

## Cleaning and Storage

1. Slide the Steam ON/OFF Switch to the “” position.
2. Unplug the power cord.
3. Stand the iron on its heel rest and leave it to cool down for 30 minutes.
4. Remove the water tank, open the Water Inlet Cap, and drain any remaining water. Close the Cap when finished.
5. Wipe the Main Body and Soleplate with a soft cloth lightly moistened with water.
  - **DO NOT clean the Soleplate with detergents or descalers.**
  - **DO NOT clean the Soleplate with abrasive or corrosive products.**
  - **DO NOT submerge the unit or hold the unit under running water.**
6. Roll up the power cord, and put the device and measuring cup in a cool, dry place.

## Mineral Build-up

It is recommended to clean the water tank every two months to reduce mineral buildup that can affect the performance of the iron.

1. Make a mixture of distilled water and vinegar in a ratio of 1:1.
2. Using the included Measuring Cup, pour the water-vinegar solution into the Water Tank. Close Water Tank Cap.
3. Follow the normal steam ironing procedure. Allow the unit to steam out the full contents of the Water Tank.

- When finished, turn off the steam and unplug the unit.
4. Stand the iron on its heel rest and allow it to cool, then refill the Water Tank with fresh distilled water. Repeat STEP 3 until the vinegar odor dissipates.
  5. Store the unit as normal.

## Tips for Best Ironing Results

- Always iron with a lengthwise motion. Ironing in a circular motion may stretch fabric.
- Natural fibers such as cotton and linen should be ironed slightly damp for faster, easier ironing. If they are completely dry, use steam while ironing or mist them with water prior to ironing.
- Any portion of a garment that has two layers of fabric such as pockets, seams, collars, and cuffs should be ironed inside out first.
- To press a collar, iron from the points in using small strokes of the iron. After wrinkles are removed, crease the collar into place by hand. Treat French cuffs similarly, gently creasing by hand after ironing.

## Specifications

Model:1-MR08US05

Rated Voltage: 100-125V/220-240V 50/60Hz

Rated Power: 300-473W/365-436W

Water Capacity: 1.5fl oz (45ml)

Temperature Range: 284 °F - 320 °F (140°C -160°C )



The product's packaging is made from environmentally friendly material and can be disposed of at your local recycling plant.

## Customer Service

<b>UNITED STATES</b>	Phone: +1 909-391-3888 (Mon-Fri 9:00am - 5:00pm PST) Email: ushelp@1byonebros.com
<b>CANADA</b>	Email: cahelp@1byonebros.com
<b>UNITED KINGDOM</b>	Email: ukhelp@1byonebros.com
<b>GERMANY/FRANCE ITALY/SPAIN</b>	Email: euhelp@1byonebros.com

## BRAND OWNER

1byone Products Inc.

1230 E Belmont Street, Ontario, CA, USA 91761

Customer Service: +1 909-391-3888

www.1byonebros.com