

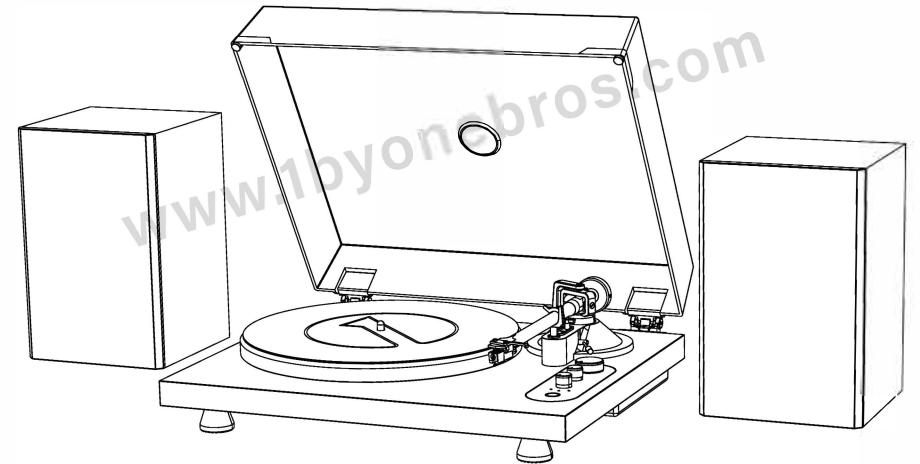

Turntable Hi-Fi System with Speakers



1byone Products Inc.
1230 E Belmont Street, Ontario, CA, USA 91761
Customer Service: +1 909-391-3888
www.1byonebros.com

Instruction Manual

Made in China

Introduction

Thank you for purchasing 1byone Turntable Hi-Fi System with Speakers. This instruction manual contains important information about safety, usage and disposal. Use the product as described and keep this manual for future reference. If you sell this turntable or pass it on, also give this manual to the new owner.

Safety Instructions

Read and understand this entire manual before using this product. Keep these instructions for future reference.

1. Do not use the turntable near water.
2. Only connect the turntable to a power outlet type as indicated on the marking label or in the "Specifications" section of this instruction manual.
3. The turntable has a polarized plug (one pin is wider than the other). To reduce the risk of electric shock, this plug is intended to fit into a polarized outlet in only one orientation. If the plug does not fit fully into the outlet, reverse the plug. If it still does not fit, contact a qualified electrician. Do not attempt to modify the plug in any way.
4. Protect the power cord from being walked on or pinched, particularly at the power plug, at the point of connection between the plug and outlet and at the point of connection between the power cable and speaker.
5. Do not overload wall outlets or extension cords as this will be a fire hazard and may cause electric shock.
6. Never push objects of any kind into the turntable through openings as they may touch dangerous voltage points or short out parts that could result in a fire or electric shock. Never spill liquid of any kind on the product.
7. Do not attempt to service the turntable yourself as opening or removing body panels may expose you to dangerous voltage or other hazards. Refer all servicing to qualified service personnel.
8. Changes or modifications to the turntable not expressly approved by the party responsible for compliance could void the user's authority to operate the product.
9. Do not use attachments not recommended by the manufacturer as they may cause hazards.
10. Only place on a flat, sturdy table or use with the cart, stand, tripod or bracket as specified by the manufacturer or sold with the turntable. When a cart is used, use caution when moving the cart/turntable combination to avoid injury from tip-over.



11. Slots and openings in the cabinet are provided for ventilation and to ensure reliable operation of the product and to protect it from overheating. Do not block or cover these openings.
12. Unplug the product during lightning storms or when unused for long periods of time.

COMPLIANCE WITH FCC REGULATIONS

This device complies with Part 15 of FCC rules. Operation is subject to the following two conditions:

- (1) This device may not cause harmful interference, and
- (2) This device must accept any interference received, including interference that may cause undesired operation.

This equipment has been tested and found to comply with the limits for a Class B digital device, pursuant to Part 15 of the FCC rules. These limits are designed to provide reasonable protection against harmful interference in a residential installation.

This equipment generates, uses and can radiate radio frequency energy and, if not installed and used in accordance with the instructions, may cause harmful interference to radio communications. However, there is no guarantee that interference will not occur in a particular installation.

If this equipment does cause harmful interference to radio or television reception, which can be determined by turning the equipment off and on, the user is encouraged to try to correct the interference by one or more of the following measures:

- Reorient or relocate the receiving antenna.
- Increase the separation between the equipment and receiver.
- Connect the equipment into an outlet on a circuit different from that to which the receiver is connected.
- Consult the dealer or an experienced radio/TV technician for help.

WARNING: Changes or modifications to this unit not expressly approved by the party responsible for compliance could void the user's authority to operate the equipment.

WARNING: Cancer and Reproductive Harm - [HYPERLINK "http://www.P65Warnings.ca.gov"](http://www.P65Warnings.ca.gov)
 For more information go to [HYPERLINK "http://www.1byonebros.com/Compliance/Prop65"](http://www.1byonebros.com/Compliance/Prop65)

Product Description

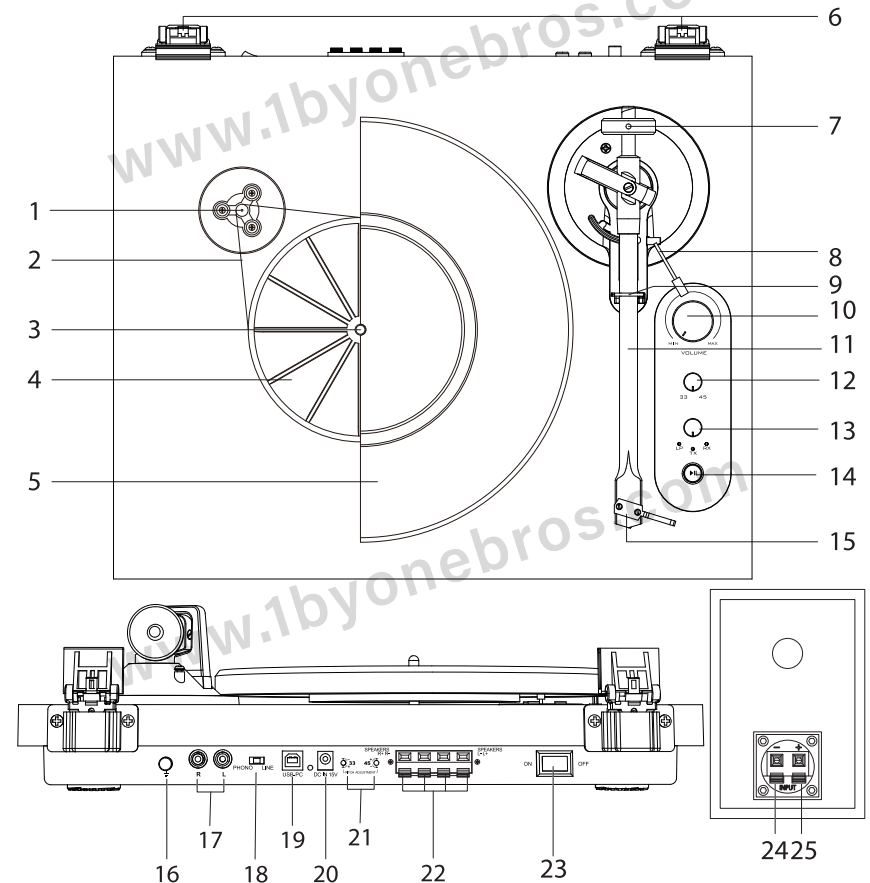

- | | | |
|--------------------------|----------------------------|-----------------------------|
| 1. Motor Pulley | 10. Volume Control | 18. Phono & Line Out Switch |
| 2. Drive Belt | 11. Tonearm | 19. USB Port for PC Link |
| 3. Turntable Spindle | 12. 33/45 RPM Selector | 20. Power Cord Jack |
| 4. Turntable Sub-platter | 13. Function Knob | 21. Pitch Adjustment Screws |
| 5. Turntable Platter | 14. Play/Stop Button | 22. External Speaker Jacks |
| 6. Lid Hinges | 15. Stylus Cartridge | 23. Power Switch |
| 7. Counterweight | 16. Ground Connector | 24. Speaker Jack - |
| 8. Tonearm Lift Lever | 17. Phono & Line Out Jacks | 25. Speaker Jack + |
| 9. Tonearm Rest & Clip | | |

Included Items

Before installing the turntable, check the package contents to ensure all parts below are included and free of visible damage. Please retain the original packaging materials for exchange or return purposes.

1 x Turntable Unit	1 x Drive Belt
2 x Speakers	1 x Sub-platter
1 x Turntable Lid	1 x Power Adapter
1 x Slip Mat	1 x USB Cable for PC Link
1 x Turntable Platter	2 x Audio Cables for Speakers
1 x Tonearm Counterweight	1 x Cartridge Alignment Protractor
1 x 45 RPM Adapter	1 x Instruction Manual

Installing the Turntable

- Place or mount the turntable on a level surface.
- To avoid the effects of vibrations and acoustic pressure if the turntable is being securely mounted with screws, do not mount directly next to speakers.
- The turntable may pick up radio static if placed next to a radio. Therefore, try to keep the turntable away from radios.
- If the turntable is near equipment (cell phone, etc.) that emits strong radio waves, noise may occur.

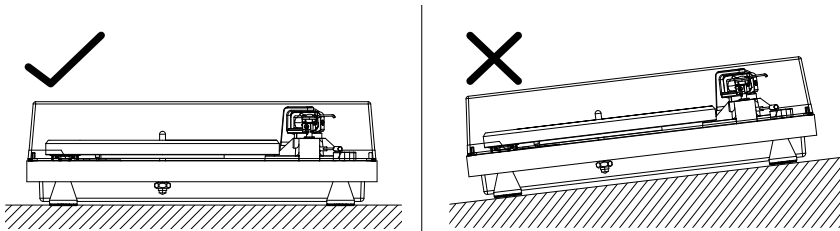

Turntable Platter and Belt Setup

1. Remove the protective packaging and ensure the turntable is placed on a sturdy and level surface.
2. Insert the sub-platter into the turntable spindle located in the middle of the turntable.
3. Loop the drive belt around the sub-platter and motor pulley (brass-colored).

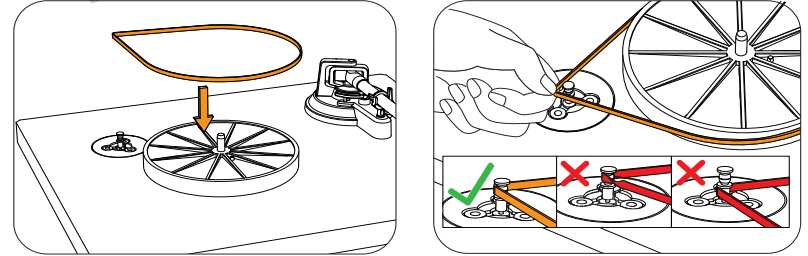

4. Rotate the Sub-Platter.
 - 1) Using your hands, slowly rotate the sub-platter ten times in a clockwise direction.
 - 2) This step is for resetting the auto mechanism, getting rid of any twists in the belt and making sure the belt rides smoothly along the drive rim on the underside of the platter.

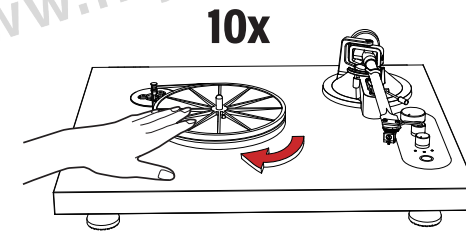

5. Carefully place the main platter onto the sub-platter.

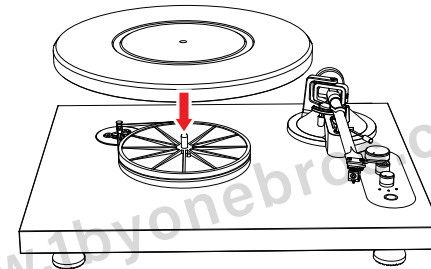

- Place the slip mat on top of the platter. Make sure the 1byone logo on the mat is facing up.

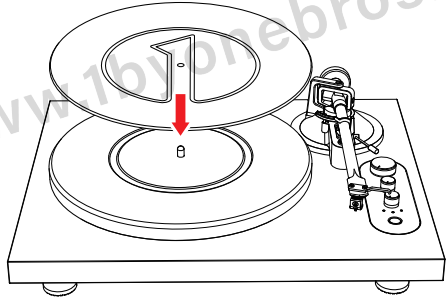

Cartridge Tracking Force Adjustment

- Gently push the counterweight onto the rear of the tonearm.

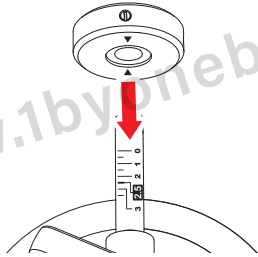

- Carefully push and pull the Counterweight and stop when it reaches the tick mark of recommended tracking force.

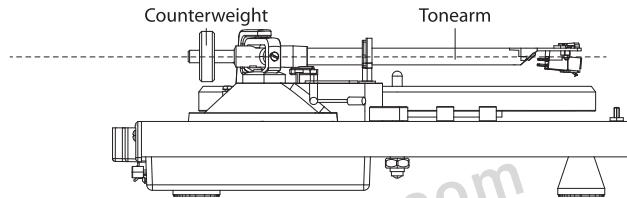
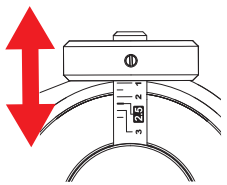

Note: Each mark on the dial represents 0.5g. The recommended tracking force for the factory-installed cartridge is $2.5g \pm 0.5g$.

- If the counterweight loosens or moves during the usage, please gently turn the screw to make it tight again.

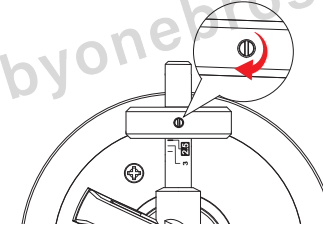

Installing the Lid

Insert the hinge pockets of the lid onto the hinges of the turntable.

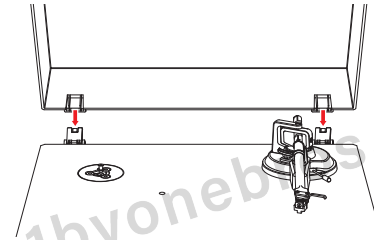

Connecting to Speakers

1. Connection to the Included Speakers

This turntable includes a built-in preamp and comes supplied with Hi-Fi speakers. Connect the speakers using the included audio cable (**black cable to black cable clamp and red cable to red cable clamp**).

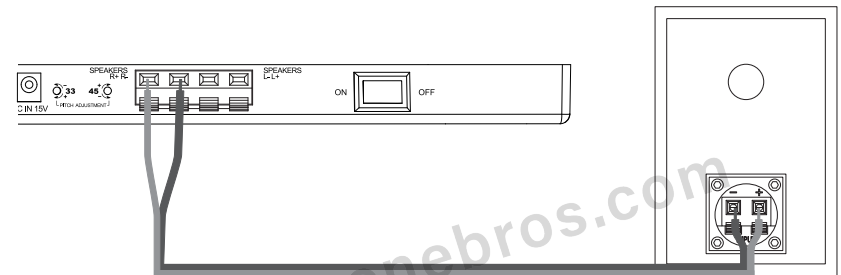

2. Connection to External Speaker with the RCA Audio Cable

If you wish to use your own amplifier or speakers, please follow the instructions below:

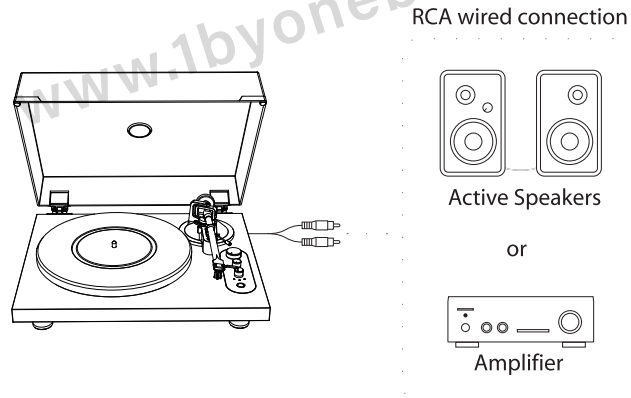

2.1 Setting pre-amplifier selector switch

This product has a built-in phono equalizer function. You can use the product even if you do not have a phono amplifier or connectable equipment with a built-in phono amplifier.

Use the pre-amplifier selector switch to set the output, as shown below.

Connectable equipment being used	Position of pre-amplifier selector switch	Where to connect RCA audio cable
Device with phono input	PHONO	Phono input jack and ground (earth) terminal of connectable equipment
Device without phono input	LINE	AUX or line input jack of connectable equipment

When connecting via the included speakers, using the pre-amplifier selector switch is not necessary.

NOTE: The RCA Jacks are not designed to be connected directly to the passive/unpowered speakers on LINE mode. If connected to the passive speakers, there will be no sound.

2.2 Connecting the device

Align the settings for the pre-amplifier selector switch and connect the RCA audio cable to an input jack that is compatible with the connectable equipment you are using (amplifier, active speakers, etc.).

- The RCA audio cable's red jack is for the right (R) channel, and the white jack is for the left (L) channel.

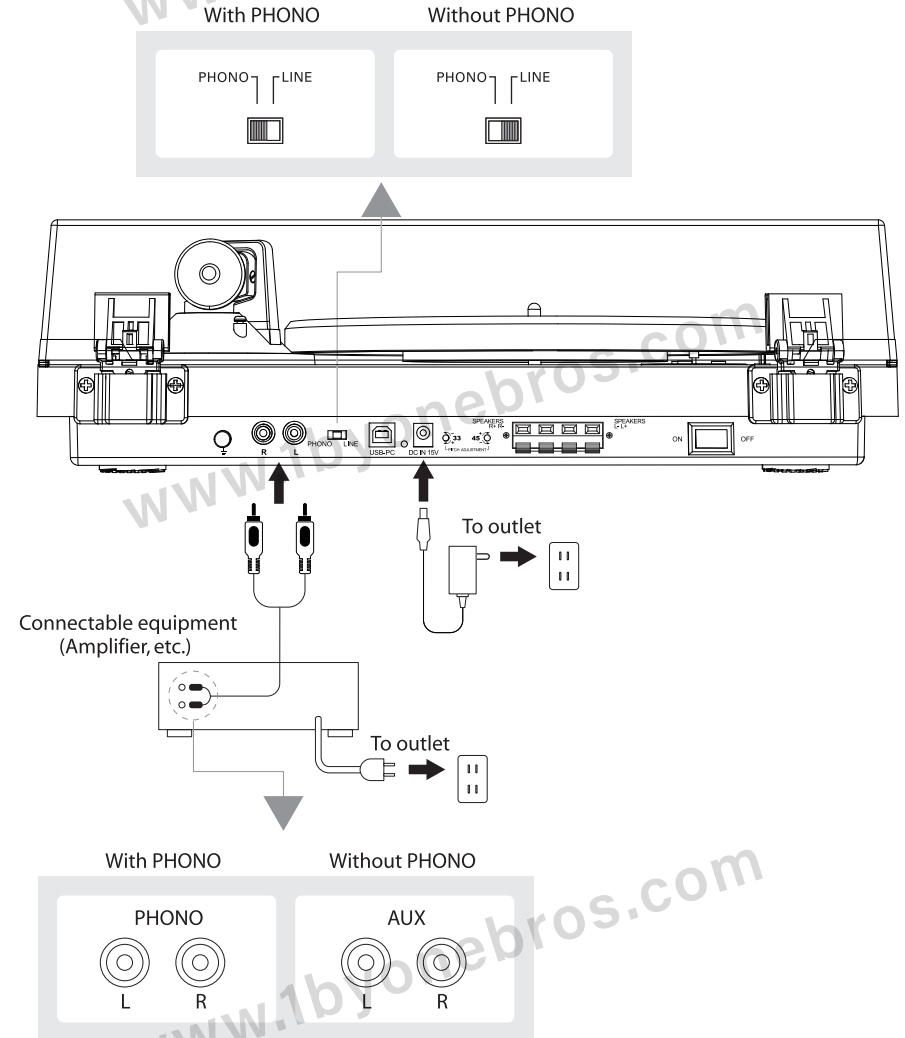

Main Power Connection

1. Insert the DC plug of the AC adapter cord into the DC INPUT Jack at the back of the turntable.
2. Plug the AC adapter into a normal power outlet.

NOTE: Do not plug the AC power adapter into a power outlet before all turntable assembly is completed. Before turning on turntable power, recheck all connections to make sure they are correct and secure. Always turn off the turntable before connecting or disconnecting from power.

Playing a Record

1. Before playing a record

- 1.1 Pull the protector straight forward to remove it.

NOTE: Applying a downward force may cause the stylus to come off the body. Only low volume will be output if the stylus has come off, or is about to come off, so refer to "Replacing the stylus" to reattach the stylus correctly.

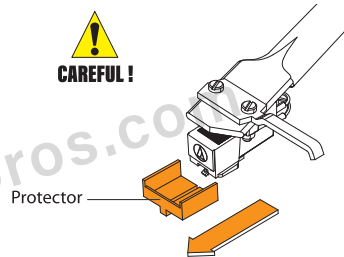

- 1.2 Place the record on the felt mat so that the center hole aligns with the spindle.

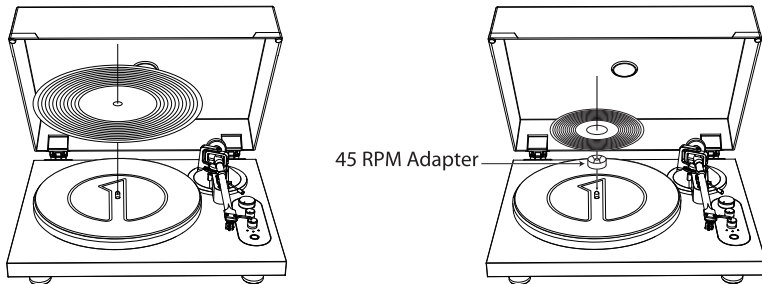

If playing a 45 RPM record with a large center hole, attach the 45 RPM adapter.

2. Turntable Operation

Sufficiently lower the volume of the amplifier, speakers, etc.

- 2.1 Connect the included power adapter to the turntable and slide the Power Switch to the "ON" position.
- 2.2 Remove the stylus protector from the stylus.
- 2.3 Place the record on the slip mat. If using 45RPM records, put the 45RPM adapter on the center spindle before placing the record on the platter.
- 2.4 Rotate the 33/45 RPM Selector according to the type of record.
- 2.5 Rotate the Function Knob to LP, press the Play/Stop Button. The platter will start spinning.
- 2.6 Unlock the tonearm clip and set the tonearm lift lever to the up position.
- 2.7 Position the tonearm over the desired location (groove) on the record.
- 2.8 Carefully lower the tonearm on the record.
- 2.9 Turn up the volume of the turntable as needed.
- 2.10 When you are finished playing the record, set the tonearm lift lever to the up position, raise the tonearm and return it to rest on the arm clip. Press the Play/Stop button to stop.



45RPM Adapter

NOTE:

1. If the silent pause time between each track is longer than 3 minutes, the platter will stop spinning automatically to avoid damaging the record. This stoppage does not mean the turntable is defective.
2. If the felt mat gets dirty, it can easily scratch the record, so remove the felt mat periodically and wipe off any dust.
3. To prevent the record from scratches and warping, remove it after use.
4. Do not use a disk stabilizer.

Wireless Operation

This appliance is equipped with Bluetooth (TX and RX mode). TX mode allows this turntable to wirelessly transmit audio to your Bluetooth speaker or headphone. In RX mode, you can connect your media device to this turntable and play music through it.

1. TX Mode

- 1.1 Power on your Bluetooth speaker or headphone and ensure it's in pairing mode.
- 1.2 Power on the turntable. Rotate the Function Knob to TX. The blue indicator light under TX will turn on.
- 1.3 When pairing, the light will flash twice per second and will become solid when paired successfully.
- 1.4 This turntable will connect to the nearest Bluetooth speaker. If you need to connect again, rotate the Function Knob to LP, and then rotate it to TX to start over.

2. RX Mode

- 2.1 Rotate the Function Knob to RX. The blue indicator light under RX will turn on.
- 2.2 Turn on the Bluetooth feature of your media device and search for and select "BT10-music" to pair the media device and turntable.
- 2.3 Once your media device is successfully paired with the turntable, the turntable will play a short confirmation sound. Stream music from your media device to the turntable.

NOTE:

1. The Play/Stop button can only control the operation of the platter. To control music streaming through Bluetooth, please use the control panel of your media device.
2. Bluetooth version: 5.0

Recording the Vinyl to Your Computer

Please follow the below steps to set up Audacity to record from the USB audio device. For more details, please refer to the BRIEF INTRODUCTION OF AUDACITY at https://manual.audacityteam.org/man/recording_with_usb_turntables.html

Please notice that the turntable's USB-PC recording function is only available in LP mode and does not work in Bluetooth mode.

1. Download the Audacity software and complete installation

- 1.1 **Ensure your Audacity software is up to date.** You can download the current version from <http://www.audacityteam.org/download/>
- 1.2 **Follow the instructions to complete installation.**

2. Set up Audacity to record from the USB audio device.

2.1 Connect the USB device

Use the supplied USB cable to connect your turntable and your computer. No extra driver is required.

2.2 System settings needed for Windows and Mac

Windows:

1. By the system clock, right-click over the **Speaker icon** select **Sounds** then the **Recording** tab, and then click on the **USB device** in the list and click **Properties**. Click the **Advanced** tab set your required bit rate and sample rate from the **Default Format** dropdown (normally "**2 channel 16-bit 44100 Hz**").
2. On the Advanced tab, in the "Default Format" section, make sure the dropdown menu is set to "**2 channel 16-bit 44100 Hz**".

For a more detailed walk-through of the above steps for Windows (or if that does not work for your version of Windows), see **Windows: accessing the Windows Sound controls**.

Mac:

1. From **Apple Menu > System Preferences** select "Sound" and click on the *Input* tab
2. Select "USB Audio CODEC" or similar as the input device and verify the **Recording Meter** shows input.
3. If the recording meter in the Sound preferences panel does not show input:
 1. From the Finder, select **Go > Utilities** and open **Audio MIDI Setup**.
 2. If the *Audio Devices* window is not visible, select **Window > Show Audio Devices**.
 3. Select your USB input device in the list in the left pane of the Audio Devices window.
 4. Set the Format to "**44100.0 Hz**" and "**2ch-16bit**".

For a more detailed walk-through of the above steps for Mac, see **Mac and USB input devices** on the Audacity Wiki.

2.3 Launch Audacity.

If Audacity is already running when you connected the cable, choose **Transport > Rescan Audio Devices** or restart Audacity.

2.4 Project Rate

Set the Audacity Project Rate in **Selection Toolbar** at the bottom left of the Audacity screen to 44100 **Hz**:



2.5 Devices

Use **Device Toolbar** to set the recording and playback devices and to set the recording channels to "2 (Stereo) Recording Channels", as in the below example on Windows 10:



- The Recording Device is set to the USB device (in this case the device name, but often called including the phrase "USB Audio CODEC").
- Recording Channels is set to stereo.
- The Playback Device is set to the named speakers of the built-in computer sound device.
- These settings can also be changed in **Devices Preferences**.

Windows calls most USB external devices "microphones". Some higher-end USB recording interfaces may appear as their explicit manufacturer's name.

3. Software Playthrough

Use **Transport > Transport Options > Software Playthrough (on/off)** and click "**Software Playthrough**" to turn it "on" (the checkmark is shown when it is "on"). This setting can also be enabled or disabled in **Recording Preferences**. Software Playthrough lets you hear the turntable through the computer speakers when recording. It also lets you hear the turntable *without* recording if you turn on monitoring (see the next section below).

4. Monitoring

Enable monitoring to set the recording level

- Turn monitoring on by clicking once on the microphone icon in the **Recording Meter**.

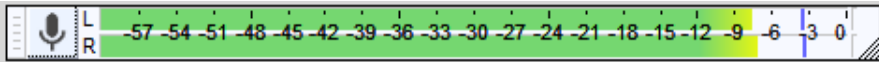

- In **Mixer Toolbar**, turn up the left-hand playback volume slider (by the speaker icon).



- The right-hand recording volume slider (by the microphone icon) can often be used to vary the loudness of the recording, but it may not function with all turntables. If it does not, try adjusting the output level on the turntable (often, there is a gain control under the chassis).

Alternatively, you may be able to adjust the input level on Windows and Linux only, usually by looking for the speaker icon by the system clock. On **Windows, right-click over the speaker icon > "Recording Devices"**. Then right-click over USB Audio Codec, choose "Properties" and click the *Levels* tab.

- Try to aim for a maximum peak of around -6 dB, which corresponds to around 0.5 on the **waveform**. You can always boost the level later with **Effect > Amplify...** or **Effect > Normalize...** after you have completed editing.

5. Recording

Then, ignoring any instructions in the manufacturer's guide to select "stereo mix", simply press the **Record** button  in **Transport Toolbar** to start recording from the turntable.

6. Recording, editing and exporting

Once your USB turntable is set up and working properly, go to the **Basic Recording, Editing and Exporting** section of Audacity's **Tutorial - Copying tapes, LPs or MiniDiscs to CD** for instructions on how to:

- make and edit your recording
- export it to an audio file
- import it to iTunes or Windows Media Player
- burn it to CD

Audacity's reference links:

- **Basic Recording, Editing and Exporting** : https://manual.audacityteam.org/man/basic_recording_editing_and_exporting.html
- **Tutorial - Copying tapes, LPs or MiniDiscs to CD** : https://manual.audacityteam.org/man/tutorial_copying_tapes_lps_or_minidiscs_to_cd.html

Care

Turntable Body

- When the turntable body is dirty or dusty, first disconnect the AC adapter and then wipe off the dirt and dust with a soft, dry cloth.
- Do not use benzenes, thinners, etc.
- When storing the product for a long time, disconnect the AC adapter from the outlet and wrap the product in plastic; do not allow it to become damp; the drive belt should be removed to prevent unequal stretching.

Tips for Stylus Cleaning

- If dirt and grime are stuck to the stylus tip, clean it with a commercially sold brush.
- We recommend using a stylus cleaner (not included) if the stylus tip is considerably dirty. Clean the stylus tip by moving the brush from the rear to the front of the stylus tip.

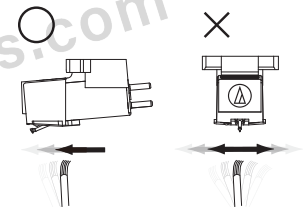

Replacing the Stylus

It's suggested to replace the stylus after 400 hours of use.

Removing the Stylus

- In addition to the deterioration of sound quality, records may also be damaged as the cartridge's stylus tip wears down.
- Be sure to disconnect the product's AC adapter from the outlet.
- When replacing the stylus, hold the headshell and the cartridge body tightly. Rotate the front of the stylus in a forward and down motion.

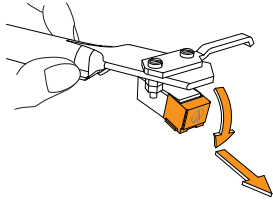

Installing a New Replacement Stylus

1. Mount the new replacement stylus to the cartridge.

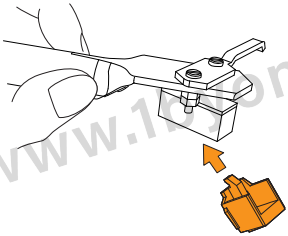

Engage in body first

2. Lift the stylus up until you hear a click.

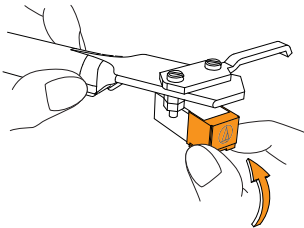

3. Make sure there is no gap between the headshell and the cartridge.

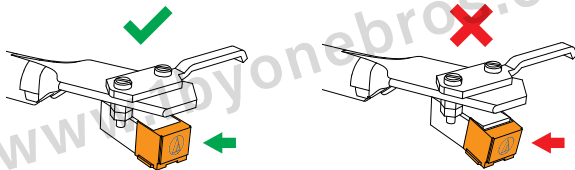

Replacing the Belt

- The belt is a consumable part. Replace the belt if the speed of playback slows down or irregular rotation occurs. **As a rule of thumb, we suggest replacing the belt once a year.**
- Before replacing the belt, be sure to disconnect the product's AC adapter from the outlet.

1. Remove the slip mat.

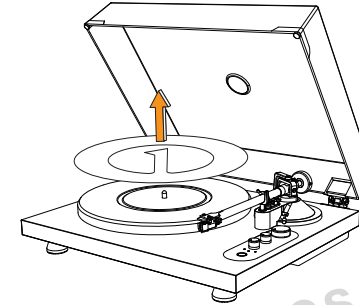

2. Remove the main platter and then remove the old belt.

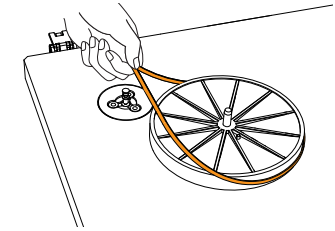
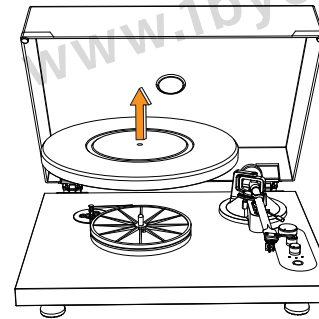

3. Loop the new belt around the sub-platter and motor pulley.

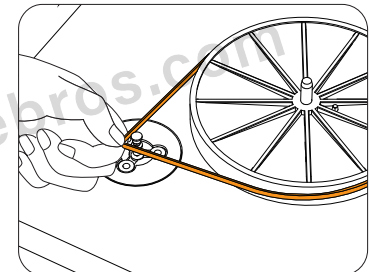
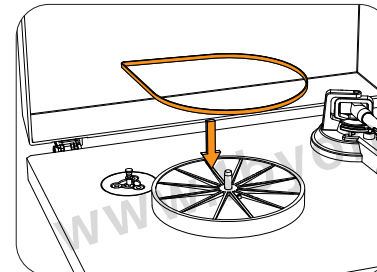

4. Using your hands, slowly rotate the platter ten times in the direction of the arrow.

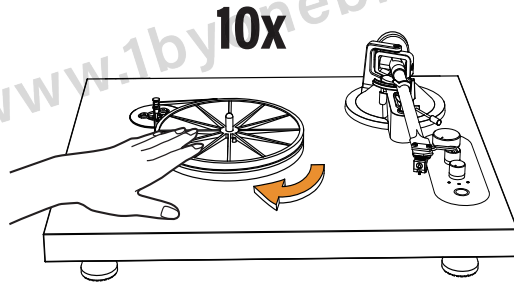

5. Place the main platter back onto the sub-platter.

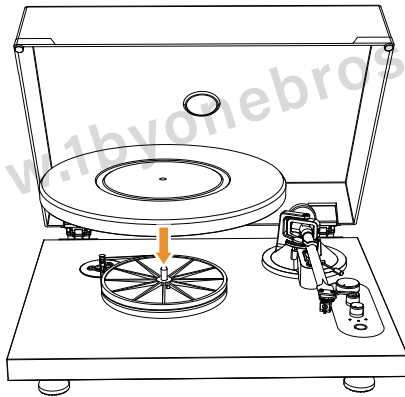

Cartridge Replacement

1. Before replacement, put the stylus protector back on the stylus to prevent damage to the stylus during the replacement process.
2. Carefully remove the wire leads from the original cartridge.
3. Loosen the two screws on the headshell that are securing the cartridge and then remove the original cartridge.
4. Mount the new cartridge to the headshell and tighten it lightly. Do not completely tighten the screws at this moment.

5. Connect the wire leads to the new cartridge's terminals. The wire lead color codes are as below:

Wire	Channel
White	Left channel positive (L+)
Black	Left channel negative (L-)
Red	Right channel positive (R+)
Black	Right channel negative (R-)

6. Adjust the cartridge's position to make sure it is precisely aligned on the headshell so that the stylus will be appropriately tracking within the grooves.

To achieve this, place the included paper **cartridge alignment protractor** over the turntable spindle, carefully lift the tone arm, and place the tip of the stylus on the points marked 130mm and 250mm respectively. Fine tune the cartridge's position on the headshell until the cartridge is perfectly in parallel with the reference lines at both points.

7. Tighten the screws completely once perfect alignment is achieved.

NOTE: If you are unfamiliar or uncomfortable with completing this procedure, we recommend consulting with a professional to perform the installation.

When the Turntable is Moved

Using the product's original packing materials, wrap the turntable in the reverse order from when you unwrapped it. If you do not have the packaging materials, take the following measures:

- After disconnecting the AC adapter from the outlet, remove the felt mat and platter, and then wrap them so that they do not get damaged.
- Attach the protector to the cartridge.
- Use a string or something similar to tie the tonearm to the rest so that it does not become dislodged.
- Wrap the turntable body with paper or a soft cloth so that it does not get damaged.

Troubleshooting

Problem	Solution
The platter does not spin.	<ul style="list-style-type: none"> Is the AC adapter connected to the outlet? -Connect the AC adapter to the outlet. What's the status of the indicator light? -The indicator light is off. That means the turntable is not turned on. Follow the operation steps to start the turntable. -The indicator light is on. Rotate the function knob to the correct position according to your connection method(via audio cable or Bluetooth). Has the belt slipped from the platter? -Correctly place the belt on the platter. Is the belt placed on the motor pulley? -Check that the belt is placed on the motor pulley (brass-colored) correctly. Has the belt been damaged? -Replace it with a new belt.
The platter spins, but there is no sound or the volume is not loud enough.	<ul style="list-style-type: none"> Are the function settings and input for connected equipment (amplifier, etc.) selected correctly? -Check whether the settings for the connected equipment are correct. Is the stylus damaged? -Check the stylus and replace it, if necessary. Is the stylus placed correctly on the body of the cartridge? -Check the cartridge and adjust it, if necessary. Are the setting positions for the pre-amplifier selector switch correct? -If you are connection to the speaker (not the speakers from the pack) with RCA audio cable, check that the pre-amplifier settings are correct, noting the following common problems and their causes: -If there is no sound, or if the volume is not loud enough, the product is set to the "PHONO" position and connected to the amplifier's AUX/LINE input. -If the volume is too loud or is distorted, the product is set to the "LINE" position, and the connectable equipment is connected to the PHONO input.

The stylus skips.	<ul style="list-style-type: none"> Is the record warped? -Check the record. Is the record scratched? -Check the record. Is the tracking force set too light? -Adjust the tracking force correctly.
There is howling.	<ul style="list-style-type: none"> Is the product picking up excessive vibrations from the floor, surfaces of the walls, or nearby speakers? -Decrease the vibrations or mount the product on a surface that is not subject to the effects of vibrations. Is the product mounted on an unstable surface? -Check whether the surface on which the product is mounted is suitable.
There is noise when the record is playing.	<ul style="list-style-type: none"> Is there dust on the cartridge's stylus tip? -If dust is stuck to the stylus tip, clean it with a commercially sold brush.
The sound when the record is playing is either too fast or too slow.	<ul style="list-style-type: none"> Are the speed settings for this product correct? -Please select the correct speed for the type of record being played.
Playback speed slows down or there is irregular rotation.	<ul style="list-style-type: none"> Is the belt stretched out? -Replace with a new belt. The motor speed is abnormal and needs to be fine-tuned. -Use the adjustment screws to carefully adjust the speed.
Needle is not touching the record.	<ul style="list-style-type: none"> The screw on the tonearm rest may have loosened during transport. Gently turn this screw clockwise to move the needle stylus closer to the record.
Needle is scratching the record's surface.	<ul style="list-style-type: none"> Gently turn the tonearm rest screw anticlockwise to move the needle stylus away from the turntable.

NOTE: Factory screw tightness is based on the thickness of the included slip mat. If a thinner or thicker 3rd-party slip mat is used, gently adjust the screw as needed following the steps in the last two trouble shooting topics.

Does the arm automatically go onto the record to play and vice versa?

- The turntable is not automatic, so you should manually put the tonearm onto the record or put it back. However, the platter will stop spinning 3 minutes after the record ends.

Can't connect to the Bluetooth speakers, any suggestions?

1. When connecting Bluetooth for the first time, please reset the Bluetooth speaker or Bluetooth headphones that you want to connect and clear all Bluetooth pairing records.
2. Please turn off other devices' Bluetooth function except for the Bluetooth speaker or Bluetooth headphones you want to connect (including the Bluetooth on your phone).
3. Please rotate the Function Knob to TX.
4. The initial connection may take longer, usually between 30 to 80 seconds. After a successful connection, the subsequent connection time will be shortened to 10 seconds. But due to differences in Bluetooth protocols among various brands and models of speakers or headphones, the connection time may sometimes be extended. Please be patient and wait.
5. Due to differences in Bluetooth protocols among various brands and models of speakers or headphones, there may be cases where the Bluetooth connection is unsuccessful.

How to adjust the speed?

- Please use the screws to adjust speed after excluding other causes that may affect the speed.
- Start the turntable. When the platter is spinning, use a slotted/flathead screwdriver to turn the pitch adjustment screws carefully to adjust the speed.

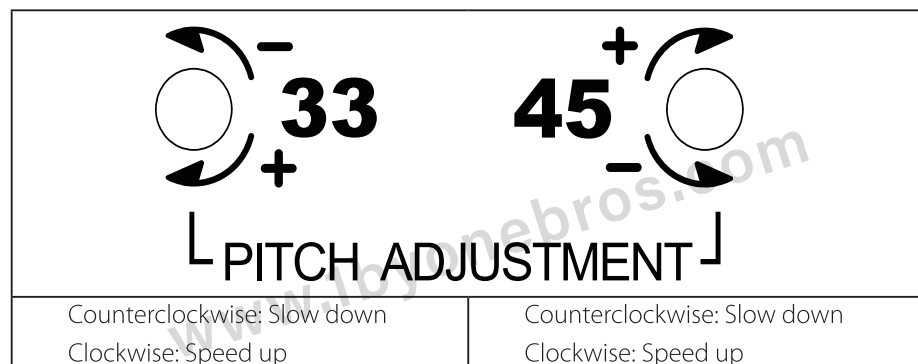

Specifications

Turntable

Model	1-AD07US07, LP10
Power	AC power adapter, DC output 15V 2000mA
Power Consumption	70W
Turntable Speed	33 1/3, 45 RPM
Wow and Flutter	±0.15%
Signal to Noise Ratio	45dB
Tracking Force Range	0-3.5g
Effective Tonearm Length	8.6" (218.5mm)
Dimensions (L x W x H)	16.54" x 14.35" x 4.86" (42 x 36.44 x 12.34cm)
Weight	22.5lb (10.2kg)

Stylus

Model	Audio-Technica AT3600L
Frequency Response	20Hz - 20kHz
Channel Balance	<2.5dB
Channel Separation	>18dB
Output Voltage	2.5mV
Recommended Load Resistance	47kΩ
Amplifier Connection	MM (Moving Magnet) - input
Recommended Tracking Force	2.5±0.5g
Weight	0.18oz (5.1g)

Speaker

Output Power	18W*2
Speaker Units	Woofer: 4" Tweeter: 2"
Impedance	4 Ω
Frequency Response	50Hz-20KHz
Dimensions	6.26" x 6.06" x 9.65" (15.90 x 15.39 x 24.50cm)
Weight	8.4lbs (3.8kg)

Note: Design and specifications are subject to change without notice.



This product's packaging is made from environmentally friendly material and can be disposed of at your local recycling plant.

Customer Service/Kundenservice Service Clients/Atención al cliente/Assistenza Clienti

UNITED STATES	Phone: +1 909-391-3888 (Mon-Fri 9:00am - 5:00pm PST) Email: ushelp@1byonebros.com
CANADA	Email: cahelp@1byonebros.com
UNITED KINGDOM	Email: ukhelp@1byonebros.com
GERMANY/FRANCE ITALY/SPAIN	Email: euhelp@1byonebros.com

BRAND OWNER

1byone Products Inc.

1230 E Belmont Street, Ontario, CA, USA 91761

Customer Service: +1 909-391-3888

www.1byonebros.com